

PRESSOSTATI PRESSURE SWITCHES

autobus

catalogo | bus catalogue 2018



10

PRESSOSTATI

Pressure switches

Il **pressostato** è un dispositivo che ha il compito di **rilevare una variazione di pressione** e quindi di reagire in maniera adeguata. Al raggiungimento di una pressione minima nel lato bassa pressione o di una pressione massima in quello di alta pressione, la frizione elettromagnetica del compressore viene staccata da un interruttore di pressione oppure, a seconda dell'impianto, da un pressostato: questo, **per evitare il danneggiamento del sistema** a causa di una pressione troppo elevata oppure l'aspirazione di gas o materiali estranei a causa di una pressione troppo bassa.

The pressure switch is a security component used to detect pressure variation and react consequently. When the minimum or maximum pressure level is reached the compressor clutch is disconnected by a a shelter or by a pressure switch: this, to avoid system damage due to a too high pressure or following to gas suction or external material caused by a too low pressure.

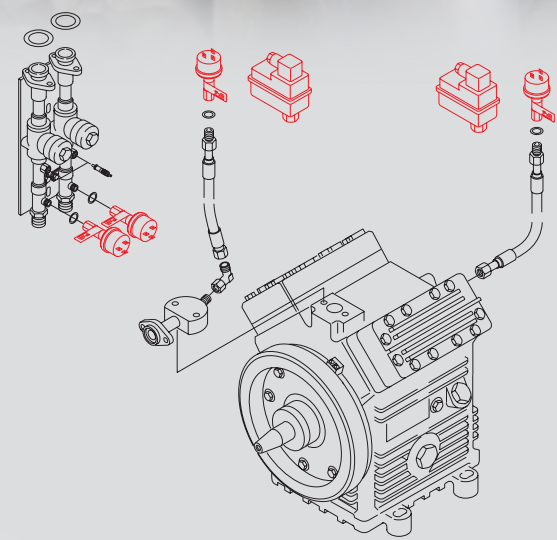
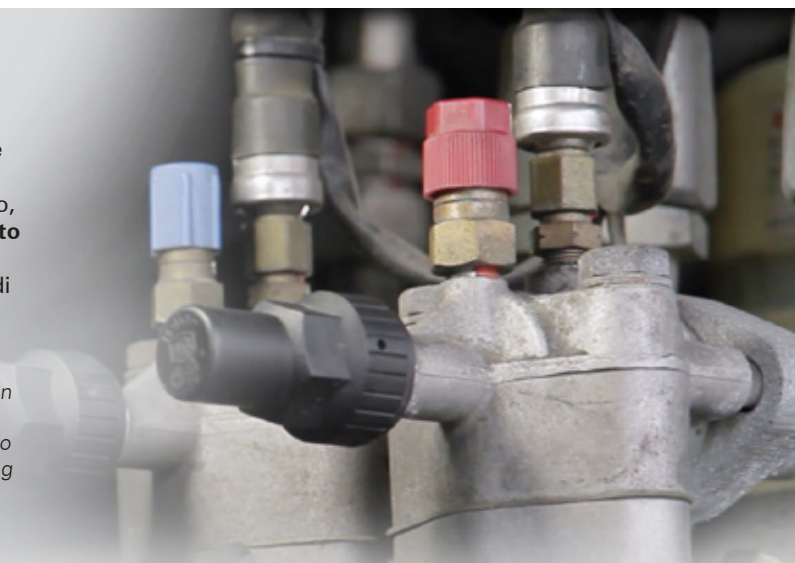

Maschio - Male



Femmina - Female

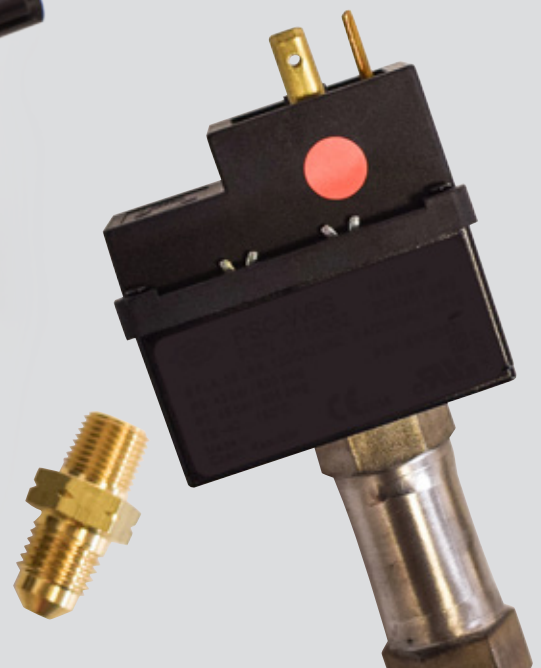

PRESSOSTATI

Pressure switches

Applicazioni varie auto/veicoli commerciali, industriali/movimento terra - Various auto/truck/special vehicles applications

	Codice Code	Descrizione Description	Attacco Fitting	Specifiche tecniche Technical specifications	OEM/Note OEM/Note
	AM 3813	Pressostato AP Pressure switch HP			
	AM 3830	Pressostato trinary Trinary pressure switch	Femmina Female		Universale Universal
	AM 3831	Pressostato trinary Trinary pressure switch	Femmina Female		Universale Universal FIAT 4280427 46413455 7741521 98482344
	AM 3832	Pressostato 4 contatti	Femmina Female	Filettatura 7/16" 20UNF-2B HP 25 off - 21 on bar LP 2 off - 2,15 on bar	Universale Universal
	AM 3833	Pressostato binary Binary pressure switch	Femmina Female	HP 24,5 off - 18,5 on bar LP 2 off - 1,9 on bar	Universale Universal 2993677
	AM 3834	Pressostato trinary CON connettore Packard Packard trinary pressure switch	Femmina Female	HP 28 off - 22,1 on bar LP 2,5 off - 2,6 on bar	FIAT 534044 2994346 93162715
	AM 3835	Pressostato trinary SENZA connettore	Femmina Female	HP 28 off - 22,1 on bar LP 2,5 off - 2,6 on bar	
	AM 3836	Pressostato trinary Trinary pressure switch	Femmina Female	HP 30 bar LP 1,2 bar	FORD 93GW19D566AA

PRESSOSTATI

Pressure switches









Applicazioni varie auto/veicoli commerciali, industriali/movimento terra - Various auto/truck/special vehicles applications

	Codice Code	Descrizione Description	Attacco Fitting	Specifiche tecniche Technical specifications	OEM/Note OEM/Note
	AM 3837	Pressostato Pressure switch	Femmina Female		DUCATO MULTIJET 2.2-2.3-3.0 46790717 51713182 51768288 51768498 5801296729 6850512
	AM 5611	Pressostato trinary DAILY Trinary DAILY pressure switch	Femmina Female	HP 28 bar LP 2,45 bar	DAILY 500317859 570770100
	AM 5694	Pressostato binary Binary pressure switch	Maschio Male	HP 27 on - 21 off bar LP 2,1 on - 2 off bar	
	AM 5683	Pressostato trinary a 4 fili	Femmina Female	Ad esaurimento	
	AM 5688	Pressostato trinary con- nettore integrato	Femmina Female	HP 28,5 bar LP 2,0 bar	FIAT/ALFA LANCIA/BRAVO/MA- REA/MULTIPLA/PALIO/ PUNTO/Y 42554631 507772100 7788280
	AM 5690	Pressostato Pressure switch	Femmina Female		
	AM 5693	Pressostato trinary 4 livelli 4 levels trinary pressure switch	Femmina Female	HP 28,0 bar LP 2,5 bar	FIAT/PUNTO/BRAVO/ DOBLÒ/MAREA/MULTI- PLA/Y/DUCATO 46476438

PRESSOSTATI

Pressure switches



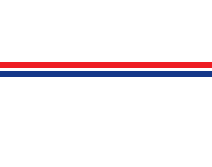

Applicazioni varie bus - Various bus applications

	Codice Code	Descrizione Description	Attacco Fitting	Specifiche tecniche Technical specifications	OEM/Note OEM/Note
	AM 5697	Pressostato differenziale automatico AP/BP	Maschio Male	HP 8 - 32 bar Diff. 4 bar LP 0,2 - 7,5 bar Diff. 0,7 - 4 bar	Universale/Bus/Rail Universal/Bus/Rail 0522145 BMB
	AM 7055	Pressostato differenziale a riarmo manuale AP/BP SAGYNOMIA	Maschio Male	HP 8 - 30 bar LP 0,6 - 6 bar	Universale Universal
	AM 7148	Pressostato differenziale a riarmo automatico AP/A.B. Johnson Controls	Maschio Male	Destra 3 - 30 bar Sinistra 0,5 - 7 bar	Universale Universal
	AM 7056	Pressostato automatico AP RANCO	Maschio Male	2,5-8 bar	Universale Universal
	AM 7149	Pressostato automatico BP RANCO	Maschio Male	Pressione di intervento: min 0,3 - max 7 bar Differenziale: min 0,6 - max 4 bar	Universale Universal
	AM 7161	Pressostato automatico BP	Maschio Male		Universale Universal
	AM 7057	Pressostato BP Pressure switch LP	Femmina Female	Open $1,6 \pm 0,1$ Close $2,0 \pm 0,1$	DK26/TM26/TM31 42532074 - 42541510 504015641
	AM 7058	Pressostato AP Pressure switch HP	Femmina Female		DK26/TM26/TM31 42532075 - 42541508 504015640
	AM 7165	Pressostato AP Pressure switch HP			
	AM 7166	Pressostato BP Pressure switch LP			

PRESSOSTATI

Pressure switches

Applicazioni varie bus - Various bus applications

	Codice Code	Descrizione Description	Attacco Fitting	Specifiche tecniche Technical specifications	OEM/Note OEM/Note
	AM 7167	Pressostato AP Pressure switch HP	Femmina Female		Renault ARES
	AM 7431	Pressostato AP Citro Citro pressure switch HP	Maschio Male	18 - 22 bar	Setra / MB 83259386003 87540009510 A0008330550 A0008331150 A0015421825
	AM 7432	Pressostato BP Citro Citro pressure switch LP	Maschio Male	0,2 / (0,4) bar	Setra / MB 83259386004 A0008330650 A0008331250 A0128200110
	AM 7433	Pressostato S328 AP ALCO S328 pressure switch HP	Maschio Male	14 - 18 bar	Setra / MB A0008311727 A0138204910
	AM 7434	Pressostato ALCO S328 BP ALCO S328 pressure switch LP	Maschio Male	0,3 - 2,7 bar	Setra / MB A0008330750

PRESSOSTATI



Pressure switches

	Codice Code	Descrizione Description	Attacco Fitting	Specifiche tecniche Technical specifications	OEM/Note OEM/Note
	AM 3842	Pressostato sovrappressione (a mezzo fermo)	Femmina Female		Konvekta e altro Konvekta and other H11000314
	AM 3843	Pressostato BP Pressure switch LP	Femmina Female		Konvekta e altro Konvekta and other H11000315 A0068209610
	AM 3844	Pressostato AP Pressure switch HP	Femmina Female		Konvekta e altro Konvekta and other H11000316 A0068209710
	AM 3845	Pressostato AP Pressure switch HP	Maschio Male		Konvekta e altro Konvekta and other H11000347 500327216 81779816008 81779816007 A0005404144
	AM 3846	Pressostato BP Pressure switch LP	Maschio Male		Konvekta e altro Konvekta and other H11000348 500327217 81779816007 A0005404244
	AM 3847	Pressostato ventole condensatore Pressure switch	Maschio Male	16/11 bar	MAN TOURLINER 81255140021 A0055459614
	AM 3848	Pressostato BP Pressure switch LP	Maschio Male	0,3 - 2,1 bar	MAN A0045400444
	AM 3849	Pressostato AP Pressure switch HP	Maschio Male	25,5 - 18 bar	MAN-SOLARIS A0045400544
	AM 3838	Pressostato BP Pressure switch LP	Femmina Female	0,3 - 2,1 bar	ISUZU HARMONY E4 A0041535628 A6135450214
	AM 3839	Pressostato AP Pressure switch HP	Femmina Female	18,0 - 25,0 bar	HARMONY E4 0041535528 A0041535528 A6135450314





PRESSOSTATI

Pressure switches



	Codice Code	Descrizione Description	Attacco Fitting	Specifiche tecniche Technical specifications	OEM/Note OEM/Note
	AM 3850	Pressostato BP 7/16" c/connettore		Max 17 bar	MAN 83255146003
	AM 3851	Pressostato AP 7/16" C/ connettore			MAN 83255146002



	Codice Code	Descrizione Description	Attacco Fitting	Specifiche tecniche Technical specifications	OEM/Note OEM/Note
	AM 5403	Pressostato BP att. Packard Hispacold	Femmina Female	1,5 - 0,5 no	4150181
	AM 5406	Pressostato AP att. Packard Hispacold	Femmina Female	24 - 19 nc	4150179
	AM 5610	Pressostato AP Hispacold Hispacold pressure switch HP	Femmina Female	24 - 19 nc Etichetta rossa Red label	4150178
	AM 5612	Pressostato BP Hispacold Hispacold pressure switch LP	Femmina Female	1,5 - 0,5 no Etichetta verde Green label	4150180



	Codice Code	Descrizione Description	Attacco Fitting	Specifiche tecniche Technical specifications	OEM/Note OEM/Note
	SU 1029	Pressostato Suttrak BP a 3 fili	Femmina Female		8883040000400 260320004 - 70419
	SU 1065	Pressostato Suttrak AP a 3 fili	Femmina Female		8883040000800 260320257

PRESSOSTATI

Pressure switches

	Codice Code	Descrizione Description	Attacco Fitting	Specifiche tecniche Technical specifications	OEM/Note OEM/Note
	SU 1193	Pressostato Sutrak AP a 2 fili - nero Packard	Femmina Female	23 - 18 bar	636115 8841030001000 704011 (ex 70407) IT704011 - IT70407
	SU 1194	Pressostato Sutrak BP a 2 fili - nero Packard	Femmina Female	0,4 - 1,7 bar	636116 8841030001100 704021 (ex 70408) IT704021 - IT70408
	SU 1298	Pressostato Sutrak BP a 2 fili - nero Packard, presa triangolare	Femmina Female		885001001000 36255146015 60501318800
	SU 1064	Pressostato Sutrak AP Sutrak pressure switch HP	Femmina Female	23,5 - 16,5 bar	Iveco 491 42547923 5006235681 81779816011 260320251 - 70401 8883040000600
	SU 1042	Pressostato Sutrak BP Sutrak pressure switch LP	Femmina Female	0,4 - 1,7 bar	Iveco 491 26.03.20.002 134154 - 70402 88-50-01-00001 8883040000300 42547924 - 50032717 5006235998
	SU 1240	Pressostato BP 0,35/2,2 Pressure switch LP 0,35/2,2	Femmina Female	0,35 - 2,2 bar	260320014 8883040002000
	SU 1264	Pressostato AP OUT 24 BAR/IN 17,8 BAR	Femmina Female	24,00 - 17,8 bar	8883040002100 260320267
	SU 1373	Pressostato Citelis Citelis pressure switch			503136425 ex 630195041 88-50-01-00021-00 8850010002100 ex 8841030000900

PRESSOSTATI

Pressure switches



THERMO KING

	Codice Code	Descrizione Description	Attacco Fitting	Specifiche tecniche Technical specifications	OEM/Note OEM/Note
	TKI 2082	Pressostato Thermo King BP Thermo king pressure switch LP	Femmina Female		8000000050MO 42550439 448734 500024329 503128422 504154930
	TKI 2036	Pressostato Thermo King AP Thermo king pressure switch HP	Maschio Male		504154927 411501 8000000049 8000000049MO
	TKI 2062	Pressostato AP AR50/SRT	Maschio Male		415220
	TKI 2080	Pressostato condensatore	Maschio Male		DOMINO 2001 447991
	TKI 2043	Pressostato AP Pressure switch HP			BMB M231 412112
	TKI 2058	Pressostato gas ventole	Maschio Male		414308
	TKI 2059	Pressostato BP Pressure switch LP	Femmina Female		414309
	TKI 2198	Pressostato controllo ventole	Maschio Male		413831

PRESSOSTATI

Pressure switches



THERMO KING



	Codice Code	Descrizione Description	Attacco Fitting	Specifiche tecniche Technical specifications	OEM/Note OEM/Note
	TKI 2232	Pressostato Gas BP Compres. X430	Femmina Female		414147
	TKI 2233	Pressostato Gas AP Compres. X430	Maschio Male		414146
	TKI 2236	Pressostato rail Rail pressure switch			ALE

	Codice Code	Descrizione Description	Attacco Fitting	Specifiche tecniche Technical specifications	OEM/Note OEM/Note
	AM 3860	Pressostato binary R134A	Maschio Male	27 - 2,0 bar	CITYSPHERE 503138428 81255250099 A0008201438 1734546 1804160204 21427043 22372600
	AM 3861	Pressostato BP con conn. AMP femm.	Femmina Female	1,8 - 0,3 bar	CROSSWAY A0005400390 22306283
	AM 3862	Pressostato AP con conn. AMP femm.	Femmina Female	24,0 - 19,0 nc	CROSSWAY 22306282
	AM 5623	Pressostato AP Pressure switch HP	Femmina Female	24,0 - 19,0	CROSSWAY 503650563 504197531 1770800

PRESSOSTATI

Pressure switches

Codice Code	Descrizione Description	Attacco Fitting	Specifiche tecniche Technical specifications	OEM/Note OEM/Note
 AM 5624	Pressostato BP Pressure switch LP	Femmina Female	1,8 - 0,3 bar	CROSSWAY 504197530 - 1770798
 AM 5646	Pressostato condensatore Aerosphere Citro	Femmina Female		83255030522 A0088209010 1891266 A6298350006
 AM 7522	Pressostato BP Pressure switch LP	Femmina Female		503139092 83259386001 A0018355206 5010013982
 AM 7523	Pressostato AP Pressure switch HP	Femmina Female		5010013983 83259386002 A0018355106 1804160686
 AM 3863	Pressostato AC REVO 20 GLOBAL AC REVO 20 GLOBAL Pressure switch			
 AM3864	Pressostato MINISPHERE MINISPHERE Pressure switch			

Codice Code	Descrizione Description	Attacco Fitting	Specifiche tecniche Technical specifications	OEM/Note OEM/Note
 AM 7442	Pressostato AP RANCO RANCO Pressure switch HP	Femmina Female		Iveco MY WAY 42471041 87540009490 A0015408944 491574
 AM 7443	Pressostato BP RANCO RANCO Pressure switch HP	Femmina Female		Iveco MY WAY 42471042 89620460340 A0015409044 491573

PRESSOSTATI

Pressure switches

Applicazioni ferroviarie - Rail applications

	Codice Code	Descrizione Description	Attacco Fitting	Note/Riferimenti Note	OEM OEM
	AM 5696	Pressostato Pressure switch	Maschio Male	DANFOSS	Rail
	AM 10045	Pressostato BP Pressure switch LP			Rail
	AM 10046	Pressostato AP Pressure switch HP			Rail
	AM 10201	Pressostato AP Pressure switch HP	Femmina Female		Rail
	AM 10202	Pressostato BP Pressure switch LP	Femmina Female		Rail
	AM 10224	Trasmettitore pressione			Rail
	AM 10225	Trasmettitore pressione			Rail
	AM 10309	Minipressostato automatico	Femmina Female		Rail

PRESSOSTATI

Pressure switches

Applicazioni ferroviarie - Rail applications

	Codice Code	Descrizione Description	Attacco Fitting	Note/Riferimenti Note	OEM OEM
	AM 10406	Pressostato AP MDVE MDVE pressure switch HP	Femmina Female		MDVE
	AM 10459	Pressostato Pressure switch	Femmina Female		VIVALTO
	AM 10532	Pressostato Pressure switch	Femmina Female		
	AM 10534	Pressostato AP Pressure switch HP	Femmina Female		
	TKI 2236	Pressostato rail Rail pressure switch			



F.lli Amadio S.p.A.

Via Piave 37/A - 31028 - Vazzola fraz. Tezze (TV)

Tel. +39 0438 488181

info@amadiospa.it - www.amadiospa.it