

COMPRESSORI E RICAMBI

Compressors and spare parts

autobus

catalogo | catalogue 2020

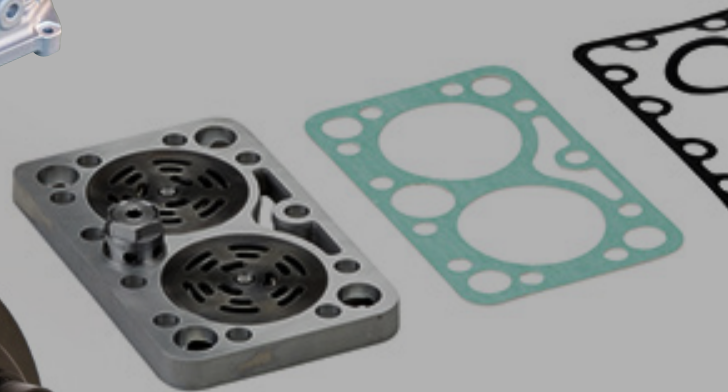
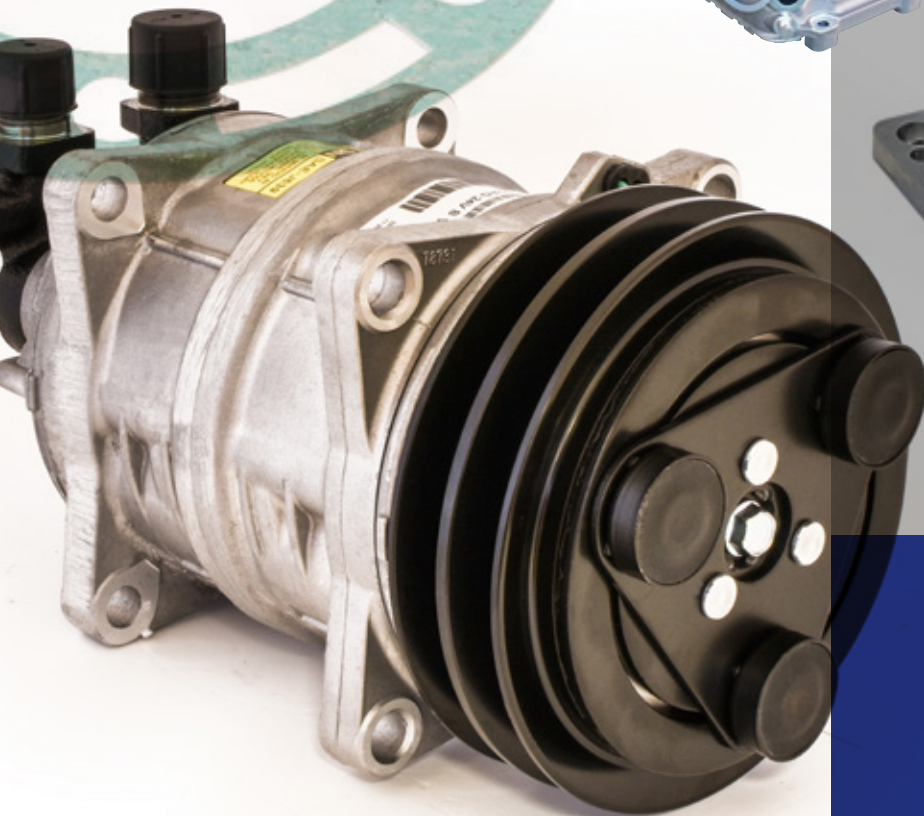

01

INDICE | INDEX

COMPRESSORI E RICAMBI SANDEN <i>Sanden compressors and spare parts</i>	P. 04
COMPRESSORI PER APPLICAZIONI ORIGINALI <i>First equipment compressors</i>	P. 13
COMPRESSORI E RICAMBI HARRISON <i>Harrison compressors and spare parts</i>	P. 16
COMPRESSORI E RCAMBI VALEO <i>Valeo compressors and spare parts</i>	P. 20
COMPRESSORI E RICAMBI GEA BOCK <i>Gea Bock compressors and spare parts</i>	P. 41
COMPRESSORI E RICAMBI BITZER <i>Bitzer compressors and spare parts</i>	P. 82
COMPRESSORI E RICAMBI HISPACOLD <i>Hispacold compressors and spare parts</i>	P. 97
COMPRESSORI E RICAMBI THERMO KING <i>Thermo King compressors and spare parts</i>	P. 104
COMPRESSORI DORIN <i>Dorin compressors</i>	P. 108
COMPRESSORI CARRIER <i>Carrier compressors</i>	P. 113

COMPRESSORI SANDEN - STANDARD

Sanden Standard Compressors

Compressori Sanden SD5H14 - STANDARD - Sanden STANDARD Compressors SD5H14

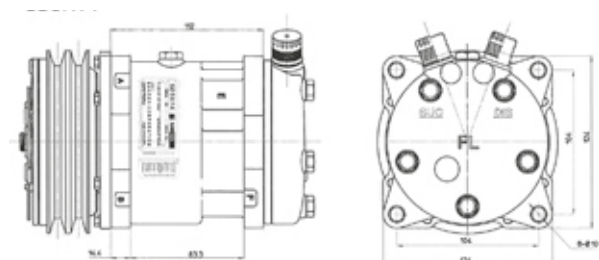

SD5H14

Dati Tecnici / Technical Data	
Cilindrata Displacement	136 cc
Numero Cilindri No. of Cylinders	5
Refrigerante Refrigerant	R134a
Tipo Olio Oil Type	SP-20 (or Equiv.) PAG 100 AM 5067
Quantità Olio Oil Quantity	175 cc
Giri MAX Maximun Speed	6000 r.p.m.
Posizione di Montaggio Mounting Position	± 90°
Rotazione Rotation	Orario Clockwise
Raccordo Aspirazione Suction Fitting	A seconda della configurazione Depending on setup
Raccordo Mandata Discharge Fitting	A seconda della configurazione Depending on setup



	Codice Code	Modello Model	Puleggia Pulley	Gole Grooves	Attacchi Fittings	Voltaggio Voltage	OEM/Note OEM/Note
	AM 55086	SD5H14	Ø 132	2 "A"	Rotolock orizzontali Horizontal Rotolock	12V	32233200 - 176185 3405689R2 - 34056 5811103 - 80450805 4513 - 6631 89508380 H13002203
	AM 55090	SD5H14	Ø 132	2 "A"	Rotolock orizzontali Horizontal Rotolock	24V	4521 - 6632 - 9265
	AM 55087	SD5H14	Ø 132	2 "A"	Rotolock verticali Vertical Rotolock	12V	1013184 - 6642 - 4525
	AM 55080	SD5H14	Ø 132	2 "A"	Rotolock verticali Vertical Rotolock	24V	6667 - 4527

COMPRESSORI SANDEN - STANDARD

Sanden Standard Compressors

Compressori Sanden SD5H14 - STANDARD - Sanden STANDARD Compressors SD5H14



	Codice Code	Modello Model	Puleggia Pulley	Gole Grooves	Attacchi Fittings	Voltaggio Voltage	OEM/Note OEM/Note
	AM 55089	SD5H14	Ø 132	2 "A"	O-ring verticali Vertical O-ring	12V	AG518204 4510 - 6626 - 6664
	AM 55082	SD5H14	Ø 132	2 "A"	O-ring verticali Vertical O-ring	24V	
	AM 57108	SD5H14	Ø 132	2 "A"	Conico verticale Vertical Flare	24V	NON PIÙ FORNIBILE, ADATTARE IL CODICE AM 55082 SD508 8399
	AM 57128	SD5H14	Ø 125	Poly-V10	O-ring orizzontali Horizontal O-ring	24V	6648 - 4537

COMPRESSORI SANDEN - STANDARD

Sanden Standard Compressors

Compressori Sanden SD7H15 - STANDARD - Sanden STANDARD Compressors SD7H15

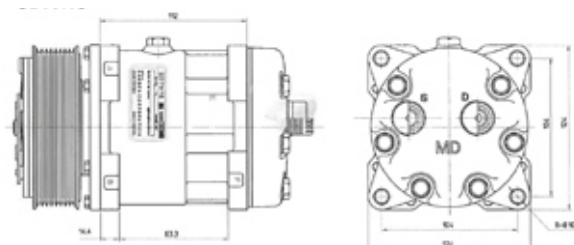

SD7H15

Dati Tecnici / Technical Data	
Cilindrata Displacement	154,98 cc
Numero Cilindri No. of Cylinders	7
Refrigerante Refrigerant	R134a
Tipo Olio Oil Type	SP-10 (or Equiv.) PAG 46 AM 5066
Quantità Olio Oil Quantity	175 cc
Giri MAX Maximum Speed	7000 r.p.m.
Posizione di Montaggio Mounting Position	± 90°
Rotazione Rotation	Orario Clockwise
Raccordo Aspirazione Suction Fitting	A seconda della configurazione Depending on setup
Raccordo Mandata Discharge Fitting	A seconda della configurazione Depending on setup



	Codice Code	Modello Model	Puleggia Pulley	Gole Grooves	Attacchi Fittings	Voltaggio Voltage	OEM/Note OEM/Note
	AM 57062	SD7H15	Ø 132	2 "A"	Rotolock orizzontali Horizontal Rotolock	12V	TESTATA "MB" "MB" Cylinder head 01103234 351126181 3550921M91 4234471M1 4646 - 7851
	AM 57060	SD7H15	Ø 132	2 "A"	Rotolock orizzontali Horizontal Rotolock	24v	TESTATA "MD" "MD" Cylinder head 503140065 504002477 11064 7933 - 8098
	AM 57206	SD7H15	Ø 132	2 "A"	Rotolock orizzontali Horizontal Rotolock	24v	TESTATA "MB" "MB" Cylinder head

COMPRESSORI SANDEN - STANDARD

Sanden Standard Compressors

Compressori Sanden SD7H15 - STANDARD - Sanden STANDARD Compressors SD7H15



	Codice Code	Modello Model	Puleggia Pulley	Gole Grooves	Attacchi Fittings	Voltaggio Voltage	OEM/Note OEM/Note
	AM 57064	SD7H15	Ø 132	2 "A"	Rotolock verticali Vertical Rotolock	12V	7403346 - 850419N 3269930 - 4643 6036 7849 - 7928 - 8258 351126211
	AM 57061	SD7H15	Ø 132	2 "A"	Rotolock verticali Vertical Rotolock	24V	42536910 - 7872
	AM 57063	SD7H15	Ø 119	Poly-V 8	Rotolock orizzontali Allineamento 46,5 Horizontal Rotolock 46,5 alignment	12V	TESTATA "MD" "MD" Cylinder head 7822
	AM 57207	SD7H15	Ø 119	Poly-V 8	Rotolock orizzontali Allineamento 50,1 Horizontal Rotolock 50,1 alignment	12V	TESTATA "MB" "MB" Cylinder head 7083
	AM 57065	SD7H15	Ø 119 mm	Poly-V 8	Rotolock verticali Vertical Rotolock	12V	11062 - 4710
	AM 57066	SD7H15	Ø 132 mm	2 "A"	O-ring verticali Vertical O-ring	12V	AG514573
	AM 57092	SD7H15	Ø 132 mm	2 "A"	O-ring verticali Vertical O-ring	24V	
	AM 57071	SD7H15	Ø 119 mm	Poly-V 8	O-ring verticali Vertical O-ring	24V	

RICAMBI COMPRESSORI SANDEN

Sanden compressors spare parts

Ricambi Sanden SD5H14 - Sanden SD5H14 spare parts





	Codice Code	Descrizione Description	Applicazione Application	OEM/Note OEM/Note
	DV 042004	Premistoppa Shaft seal 28 mm Ø est/out 15 mm Ø int/ins 17 mm H	Sanden SD5H14 1 ^ serie (SD507 - SD508 SD510 - TR80)	
	DV 042074	Cuscinetto Bearing	Sanden SD5H14 (SD507 - SD508 SD510 - SD5H11)	
	AM 5257	Kit guarnizioni Gasket kit	Sanden SD5 serie completa	
	AM 5912	Testata O-ring orizzontali Cylinder head Horizontal O-ring	Sanden SD5	
	AM 5528	Testata O-ring verticali Cylinder head Vertical O-ring	Sanden SD5	
	DV 042011	Testata Rotolock orizzontali Cylinder head Horizontal Rotolock		
	DV 042019	Testata Rotolock orizzontali Cylinder head Horizontal Rotolock	Sanden SD5	

RICAMBI COMPRESSORI SANDEN

Sanden compressors spare parts

Ricambi Sanden SD5H14 - Sanden SD5H14 spare parts



	Codice Code	Descrizione Description	Applicazione Application	OEM/Note OEM/Note
	DV 0420191	Testata Conico verticale c/fori Cylinder head Vertical Flare	Serie 5	
	AM 5325	Bobina 12V Coil 12V	Sanden SD5H14	
	AM 5522	Elettrofrizione 2 gole A Ø 132 mm 24V Electromagnetic clutches 2 grooves A Ø 132 mm 24V	Sanden SD508-510-5H14	

RICAMBI COMPRESSORI SANDEN

Sanden compressors spare parts

Ricambi Sanden SD7H15 - Sanden SD7H15 spare parts









	Codice Code	Descrizione Description	Applicazione Application	OEM/Note OEM/Note
	DV 042151	Premistoppa Shaft seal 26 mm Ø est/out 15 mm Ø int/ins 12 mm H	Sanden SD7H15	
	DV 042077	Cuscinetto Bearing	Sanden SD7H15	
	DV 042149	Kit guarnizioni posteriori Gasket kit	Sanden SD7H15 (1 ^ serie)	
	AM 5441	Bobina 24V Coil 24V	Sanden SD7H15	23006
	AM 5327	Bobina 12V Coil 12V	Sanden SD7H15	
	AM 5059	Guarnizione O-ring coperchio valvole O-ring valves cover seals	Sanden SD7H15	

RICAMBI COMPRESSORI SANDEN

Sanden compressors spare parts

Ricambi Sanden SD7H15 - Sanden SD7H15 spare parts







	Codice Code	Descrizione Description	Applicazione Application	OEM/Note OEM/Note
	DV 016095	Elettrofrizione 2 gole A Ø 132 mm 12V Electromagnetic clutches 2 grooves A Ø 132 mm 12V	Sanden SD7H15	
	DV 016096	Elettrofrizione 2 gole A Ø 132 mm 24V Electromagnetic clutches 2 grooves A Ø 132 mm 24V	Sanden SD7H15	
	DV 016097	Elettrofrizione Poly-V8 Ø 132 mm 12V Electromagnetic clutches Poly-V8 Ø 132 mm 12V	Sanden SD7H15	
	AM 5275	Elettrofrizione Poly-V8 Ø 123 mm 24V Electromagnetic clutches Poly-V8 Ø 123 mm 24V	Sanden SD7H15	
	AM 5268	Testata O-ring orizzontali Cylinder head Horizontal O-ring	SD708 SD709 SD7H13 SD7H15	
	AM 5272	Testata O-ring verticali Cylinder head Vertical O-ring	SD7H15	
	AM 5910	Testata alta Rotolock orizzontali Cylinder head Horizontal Rotolock	SD7H15	

RICAMBI COMPRESSORI SANDEN

Sanden compressors spare parts

Ricambi Sanden SD7H15 - Sanden SD7H15 spare parts









	Codice Code	Descrizione Description	Applicazione Application	OEM/Note OEM/Note
	AM 5911	Testata alta O-ring verticali Cylinder head Vertical O-ring		
	AM 5913	Testata flangiata Cylinder head flange	SD7H15	
	DV 042150	Testata Rotolock verticali Cylinder head Vertical Rotolock		
	DV 042160	Paraolio Oil Seals	SD709 SD7H15	

COMPRESSORI PER APPLICAZIONI ORIGINALI

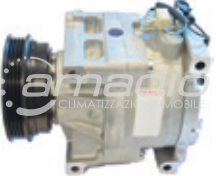
First equipment compressors

Veicoli Midibus / Minibus Motorizzati IVECO - Midibus vehicles / IVECO motorized minibuses **IVECO**



	Codice Code	Modello Model	Puleggia Pulley	Gole Grooves	Attacchi Fittings	Applicazione Application	Voltaggio Voltage	OEM/Note OEM/Note
	AM 57078	SD7H15	Ø 136	1 gola A	Rotolock orizzontali Horizontal Rotolock	IVECO Cacciamali	24V	500388059 8133
	AM 57116	SD7H15	Ø 120	Poly-V8	Rotolock orizzontali Horizontal Rotolock	IVECO Eurocargo Tector	24V	TSP0155811 4894306 8500795 11322 8090 8144
	AM 57192	SD7H15	Ø 144	1 gola A	Rotolock orizzontali Horizontal Rotolock		12V	
	AM 57083	Denso SC08C	Ø 110	Poly-V4	Flangia Flange	IVECO New Daily II 2.8D >05/99	12V	570675200 500313156
	AM 57120	Denso 10PA17C	Ø 126	Poly-V4	Flangia Flange	IVECO New Daily II 2.8TD	12V	500381465
	AM 57122	Denso 10PA17C	Ø 115	Poly-V4	Flangia Flange	IVECO New Daily II 2.3 - 3.0 TD 99>06	12V	504014391 504277234 504384698
	AM 57148	Denso 10S17C	Ø 110	Poly-V4	Flangia Flange	IVECO Daily III serie ->05/06	12V	5801362246

COMPRESSORI PER APPLICAZIONI ORIGINALI

First equipment compressors



Veicoli Midibus / Minibus Motorizzati IVECO - Midibus vehicles / IVECO motorized minibuses



	Codice Code	Modello Model	Puleggia Pulley	Gole Grooves	Applicazione Application	Voltaggio Voltage	OEM/Note OEM/Note
	AM 57115	Denso 10PA17	Ø 115	Poly-V4	IVECO Cursor 10-13 Stralis Eurostar 11/99 >02/02 New Holland CX860-880	24V	99488569
	AM 57196	Denso 10PA17C	Ø 126	Poly-V4	IVECO Cursor 8 Stralis 350	24V	504228992 504385144 98497470



Veicoli Midibus / Minibus Motorizzati MERCEDES - Midibus vehicles / MERCEDES motorized minibuses Mercedes-Benz



	Codice Code	Modello Model	Puleggia Pulley	Gole Grooves	Applicazione Application	Voltaggio Voltage	OEM/Note OEM/Note
	AM 57099	Denso 7SBU16C	Ø 126	Poly-V 6	MERCEDES Vito/Sprinter W202/S202 C208/W210 W140/R170	12V	A0002300911 A0002302011 A000230201180 A0002303911 A0002306811 A0002307011 A000230701180 A000230701187 A0002307811 A0002340911 A0002342411 A0002342911 A0002343111 A0002346303 A0002346306 A2301100070
	AM 57121	Denso 7SEU17C	Ø 115	Poly-V 6	MERCEDES W203 W211 Vito 2.2 CDI >09/03	12V	A0002306511 A0002308111 A0002308511 A0002308811 A0002309011 A0002309511 A0012300811 A0012301411 A0012301711 A0012302811 A0012305611 A0012308111 A0022301911

COMPRESSORI PER APPLICAZIONI ORIGINALI

First equipment compressors



Veicoli Midibus / Minibus Motorizzati **MERCEDES** - Midibus vehicles / **MERCEDES** motorized minibuses Mercedes-Benz

	Codice Code	Modello Model	Puleggia Pulley	Gole Grooves	Applicazione Application	Voltaggio Voltage	OEM/Note OEM/Note
	AM 57079	Denso 7SBU16C	Ø 135	Poly-V 9	MERCEDES ACTROSS 04 97>10 02	24V	A5412300611 A5412301211
	AM 57150	Denso 7SEU17C	Ø 104	Poly-V 7	MERCEDES CL	12V	447180-5510 4471805510 A0002302711 A0002306411 A0002307211 A0002307611 A0002308611 A0002309211 A0012301311 A0012303211 A0012307911 A0012308611 A0032308811
	AM 57187		Ø 125	Poly-V 6	MB Minibus	12V	



Veicoli Midibus / Minibus Motorizzati **RENAULT** - Midibus vehicles / **RENAULT** motorized minibuses

	Codice Code	Modello Model	Puleggia Pulley	Gole Grooves	Applicazione Application	Voltaggio Voltage	OEM/Note OEM/Note
	AM 57109	Harrison V5	Ø 119	Poly-V 7	OPEL Movano 1.9 - 2.2 - 2.5 DTI Vivaro 19.DTI - 2.0 16V - 2.5DTI RENAULT Master II Serie 1.9 - 2.2 - 2.5 DCI Master III Serie 2.5 DCI	12V	1135514 1140769 8200200671 8200763772 8200895038 8200979500

Qualsiasi altro modello disponibile su richiesta - Every other model available upon request

COMPRESSORI HARRISON V5

Harrison V5 compressors

Compressori Harrison V5 - STANDARD - V5 Harrison STANDARD Compressors

Webasto Diavia

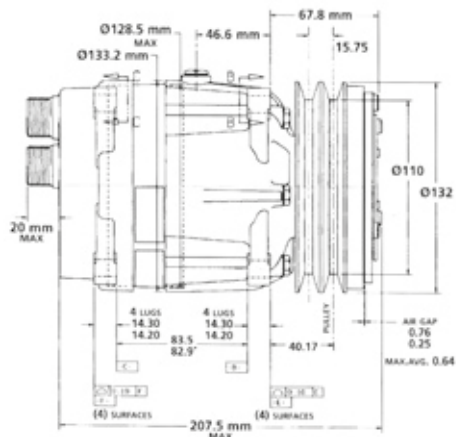

V5

Dati Tecnici Technical Data	
Cilindrata Displacement	136 cc
Numero Cilindri No. of Cylinders	5
Refrigerante Refrigerant	R134a
Tipo Olio Oil Type	PAG-150 (or Equiv.)
Quantità Olio Oil Quantity	175 cc
Giri MAX Maximun Speed	6000 r.p.m.
Posizione di Montaggio Mounting Position	± 60°/45°
Rotazione Rotation	Orario Clockwise
Raccordo Aspirazione Suction Fitting	A seconda della configurazione Depending on setup
Raccordo Mandata Discharge Fitting	A seconda della configurazione Depending on setup

	Codice Code	Modello Model	Puleggia Pulley	Gole Grooves	Attacchi Fittings	Voltaggio Voltage	OEM/Note OEM/Note
	DV 015120	V5	Ø 132	2 "A"	Rotolock orizzontali Horizontal Rotolock	12V	3552611M91 42N0756132
	DV 015122	V5	Ø 132	2 "A"	Rotolock verticali Vertical Rotolock	12V	42N0711170
	DV 015121	V5	Ø 118	Poly-V 8	Rotolock orizzontali Horizontal Rotolock	12V	6453XT 1H0820803J
	DV 015123	V5	Ø 118	Poly-V 8	Rotolock verticali Vertical Rotolock	12V	
	DV 015125	V5			Rotolock verticali Vertical Rotolock		

RICAMBI COMPRESSORI HARRISON

Harrison compressors spare parts

Compressori Harrison V5 - STANDARD - V5 Harrison STANDARD Compressors

Webasto Diavia



Ricambi Harrison V5 - Harrison V5 spare parts

	Codice Code	Descrizione Description	Applicazione Application	OEM/Note OEM/Note
	DV 042153	Premistoppa Shaft seal 30,5 mm Ø est/out 16,5 mm Ø int/ins 7,7 mm H	Harrison V5	
	AM 7009	Cuscinetto Bearing	Harrison V5	
	AM 5255	Kit guarnizioni Gasket kit	Harrison V5	
	DV 016182	Elettrofrizione 2 gole A Ø 132 mm 12V Electromagnetic Clutches 2 grooves A Ø 132 mm 12V	Harrison V5	
	DV 016183	Elettrofrizione Poly-V8 Ø 118 mm 12V Electromagnetic Clutches Poly-V8 Ø 118 mm 12V	Harrison V5	
	DV 0425010	Valvola Valve	Harrison V5	

COMPRESSORI HARRISON GM A6

Harrison GM A6 compressors

Compressori Harrison GM A6 - Harrison GM A6 compressor



GM A6

Dati Tecnici Technical Data	
Cilindrata Displacement	206 cc
Numero Cilindri No. of Cylinders	6
Refrigerante Refrigerant	R134a
Tipo Olio Oil Type	10 fl. Oz. (or Equiv.)
Quantità Olio Oil Quantity	296 cc
Giri MAX Maximun Speed	6500 r.p.m.
Posizione di Montaggio Mounting Position	± 16°
Rotazione Rotation	Orario (con opzione di modifica dell'operatore) Clockwise (with operator change options) 
Raccordo Aspirazione Suction Fitting	A seconda della configurazione Depending on setup
Raccordo Mandata Discharge Fitting	A seconda della configurazione Depending on setup

Codice Code	Descrizione Description	OEM/Note OEM/Note
AM 5007	Compressore GM A6 12V puleggia piccola Ø 125 1 gola A GM A6 Compressor 12V small pulley Ø 125 1 groove A	
AM 5006	Compressore GM A6 24V puleggia piccola Ø 125 1 gola A GM A6 Compressor 24V small pulley Ø 125 1 groove A	5001845306 D015318 D049167 - 102244 5010347723 102244
AM 5008	Compressore GM A6 24V puleggia grande Ø 145 1 gola A GM A6 Compressor 24V big pulley Ø 145 1 groove A	0254969 71201311 - 14009
AM 5009	Compressore GM A6 24V puleggia piccola Ø 125 2 gole Z GM A6 Compressor 24V small pulley Ø 125 2 grooves Z	

COMPRESSORI HARRISON GM A6

Harrison GM A6 compressors

Ricambi Harrison GM A6 - Harrison GM A6 spare parts

	Codice Code	Descrizione Description	OEM/Note OEM/Note
	AM 7001	Kit premistoppa Shaft seal kit	
	AM 7000	Kit guarnizioni Gasket kit	
	AM 7007	Mozzo frizione puleggia 1 gola Pulley clutches hub 1 groove	
	AM 7009	Cuscinetto a sfere Ball bearing	
	AM 7004	Puleggia 1 gola A Ø 125 Pulley 1 groove A Ø 125	
	AM 7005	Puleggia 1 gola A Ø 145 Pulley 1 groove A Ø 145	
	AM 7011	Puleggia 2 gole Z Ø 125 Pulley 2 grooves Z Ø 125	
	AM 7003	Bobina compressore 24V Compressor coil 24V	
	MAL OR134	O-ring - 134 O-ring - 134	

COMPRESSORI VALEO

Valeo Compressors

Tabella informativa ingombri

TM15 - TM16

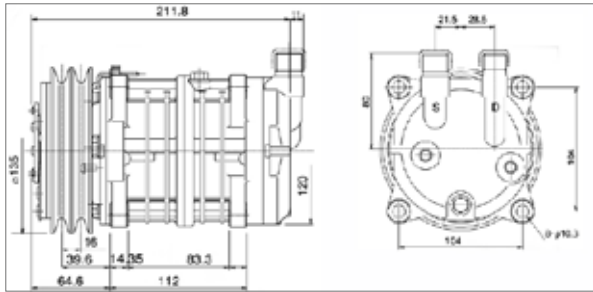

TM21

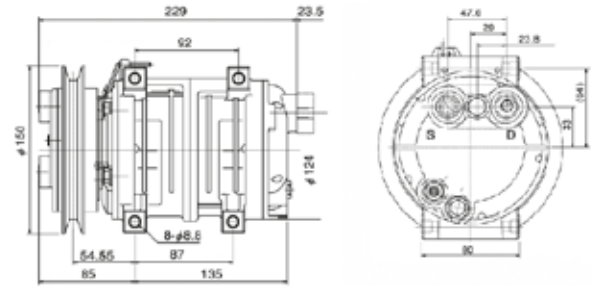

TM31

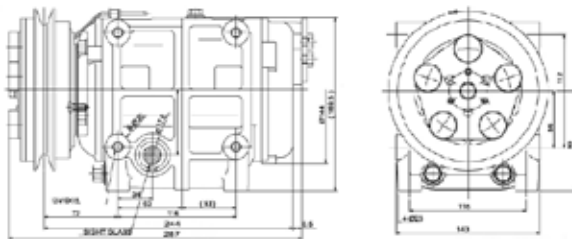

TM43

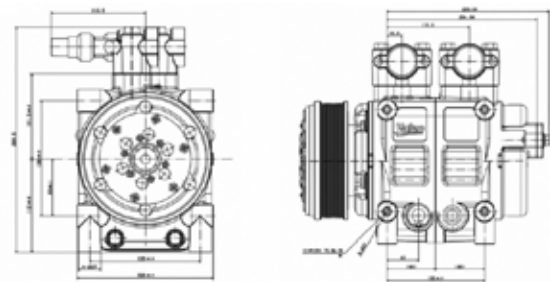

TM55

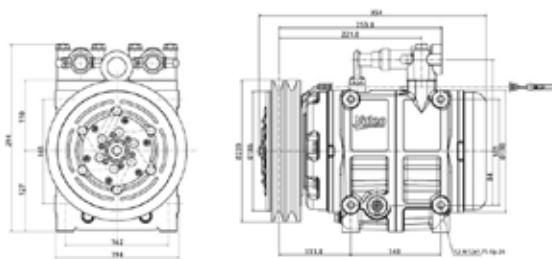

TM65

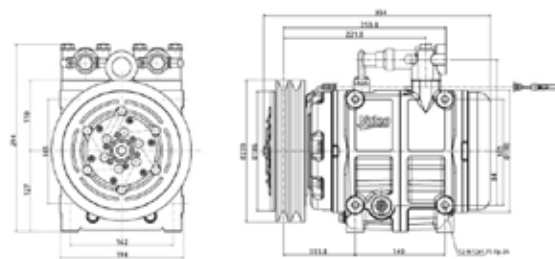

Modello Model	Cilindrata Displacement	Larghezza Width	Altezza Height	Profondità Depth	Tipo di olio Oil Type	Quantità Olio Oil Quantity
TM-15HD	146,7 cm ³	142 mm	124 mm	228 mm	ZXL 100PG (or equiv.) PAG 46 AM 5066	150 cc
TM-16HD	162,9 cm ³	142 mm	124 mm	212 mm	ZXL 100PG (or equiv.) PAG 46 AM 5066	150 cc
TM-21HX	214,7 cm ³	80 mm	150 mm	229 mm	ZXL 100PG (or equiv.) PAG 46 AM 5066	180 cc
TM-31	313 cm ³	143 mm	178 mm	278 mm	ZXL 100PG (or equiv.) PAG 46 AM 5066	500 cc
TM-43	425 cm ³	164 mm	269 mm	319 mm	ZXL 100PG (or equiv.) PAG 46 AM 5066	800 cc
TM-55	550 cm ³	194 mm	294 mm	354 mm	ZXL 100PG (or equiv.) PAG 46 AM 5066	1500 cc
TM-65	635 cm ³	194 mm	294 mm	354 mm	ZXL 100PG (or equiv.) PAG 46 AM 5066	1500 cc

COMPRESSORI VALEO TM15 (EX SELTEC - ZEXEL)

VALEO TM15 Compressors (ex SELTEC - ZEXEL)

TM15 - TM15



ORIGINAL "Made in Japan"

TM15

Dati Tecnici / Technical Data

Cilindrata Displacement	146,7 cc
Numero Cilindri No. of Cylinders	6
Refrigerante Refrigerant	In base alla versione R134a o R404
Tipo Olio Oil Type	ZXL 100PG (or Equiv.) PAG 46 AM 5066
Quantità Olio Oil Quantity	150 cc
Giri MAX Maximum Speed	6000 r.p.m.
Posizione di Montaggio Mounting Position	± 45°
Rotazione Rotation	Orario Clockwise 
Raccordo Aspirazione Suction Fitting	7/8" 14 UNF - 2A
Raccordo Mandata Discharge Fitting	3/4" 16UNF - 2A

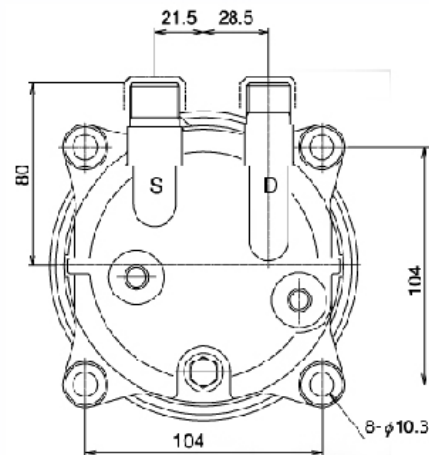
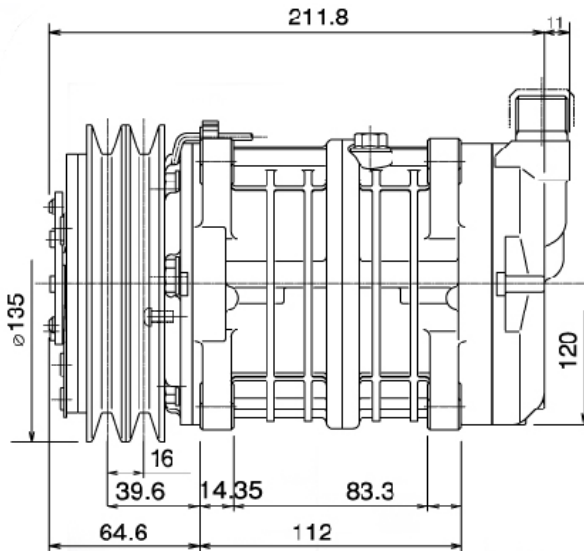

COMPRESSORI VALEO TM15 (EX SELTEC - ZEXEL)

VALEO TM15 Compressors (ex SELTEC - ZEXEL)

TM15 - TM15

	Codice Code	Modello Model	Puleggia Pulley	Gole Grooves	Attacchi Fittings	Voltaggio Voltage	Gas Gas	OEM/Note OEM/Note
	AM 5026	TM15	132 mm Ø est. Ø out.	2 "A"	O-ring verticali Vertical O-ring	12V	R134	
	AM 5115	TM15	132 mm Ø est. Ø out.	2 "A"	O-ring verticali Vertical O-ring	24V	R134	
	AM 57105	TM15	125 mm Ø est. Ø out.	2 "A"	O-ring verticali Vertical O-ring	12V	R134	
	AM 5032	TM15	125 mm Ø est. Ø out.	2 "A"	O-ring verticali Vertical O-ring	24V	R134	
	AM 5027	TM15	119 mm Ø est. Ø out.	P-V8	O-ring verticali Vertical O-ring	12V	R134	
	AM 5055	TM15	125 mm Ø est. Ø out.	2 "A"	Rotolock orizzontali Horizontal Rotolock	24V	R134	
	AM 5011	TM15	132 mm Ø est. Ø out.	2 "A"	Rotolock verticali Vertical Rotolock	24V	R404	

Qualsiasi altro modello disponibile su richiesta - Every other model available upon request

COMPRESSORI VALEO TM16 (EX SELTEC - ZEXEL)

VALEO TM16 Compressors (ex SELTEC - ZEXEL)

TM16 - TM16



ORIGINAL "Made in Japan"

TM16

Dati Tecnici / Technical Data

Cilindrata Displacement	162,9 cc
Numero Cilindri No. of Cylinders	6
Refrigerante Refrigerant	R134a
Tipo Olio Oil Type	ZXL 100PG (or Equiv.) PAG 46 AM 5066
Quantità Olio Oil Quantity	180 cc
Giri MAX Maximum Speed	6000 r.p.m.
Posizione di Montaggio Mounting Position	± 45°
Rotazione Rotation	Orario Clockwise 
Raccordo Aspirazione Suction Fitting	7/8" 14 UNF - 2A
Raccordo Mandata Discharge Fitting	3/4" 16UNF - 2A

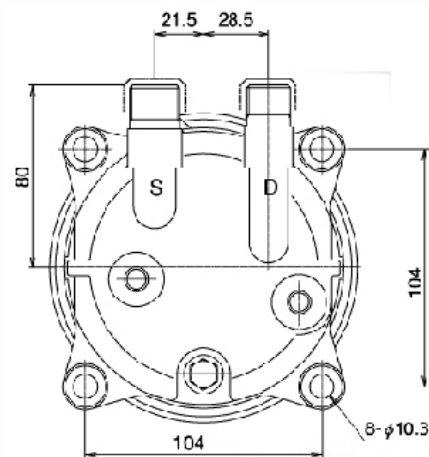
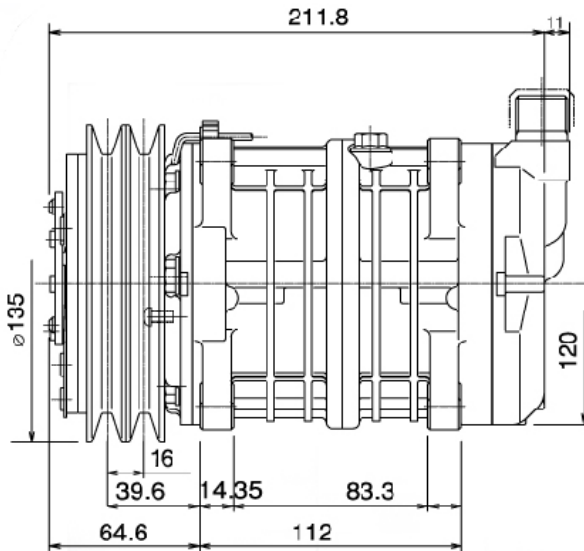

COMPRESSORI VALEO TM16 (EX SELTEC - ZEXEL)

VALEO TM16 Compressors (ex SELTEC - ZEXEL)

TM16 - TM16

	Codice Code	Modello Model	Puleggia Pulley	Gole Grooves	Attacchi Fittings	Voltaggio Voltage	Gas Gas	OEM/Note OEM/Note
	AM 5028	TM16	132 mm Ø est. Ø out.	2 "A"	O-ring verticali Vertical O-ring	12V	R134	435-56011 - 43556011 C216090L - N204829N
	AM 5016	TM16	132 mm Ø est. Ø out.	2 "A"	O-ring verticali Vertical O-ring	24V	R134	1020571 435-56015 488-46015 C216106C
	AM 5029	TM16	119 mm Ø est. Ø out.	P-V8	O-ring verticali Vertical O-ring	12V	R134	
	AM 5036	TM16	119 mm Ø est. Ø out.	P-V8	O-ring verticali Vertical O-ring	24V	R134	435-56125 488-43125 C216089K BMB D054524 D054524
	AM 5017	TM16	132 mm Ø est. Ø out.	2 "A"	O-ring orizzontali Horizontal O-ring	24V	R134	D045309
	AM 5044	TM16	132 mm Ø est. Ø out.	2 "A"	Rotolock orizzontali Horizontal Rotolock	24V	R134	
	AM 5034	TM16	119 mm Ø est. Ø out.	P-V8	Rotolock orizzontali Horizontal Rotolock	24V	R134	102668

COMPRESSORI VALEO TM16 (EX SELTEC - ZEXEL)

VALEO TM16 Compressors (ex SELTEC - ZEXEL)

TM16 - TM16

R404

	Codice Code	Modello Model	Puleggia Pulley	Gole Grooves	Attacchi Fittings	Voltaggio Voltage	Gas Gas	OEM/Note OEM/Note
	AM 5030	TM16 XS	145 mm Ø est. Ø out.	1 "A" Distanziata	O-ring verticali Vertical O-ring	12V	R404	IVECO Senza olio Without oil
	AM 5031	TM16 HD	150 mm Ø est. Ø out.	1 "A" Distanziata	O-ring orizzontali Horizontal O-ring	12V	R404	Gruppi frigo Senza olio Without oil
	AM 5045	TM16 XS	132 mm Ø est. Ø out.	2 "A"	O-ring verticali Vertical O-ring	24V	R404	Senza olio Without oil
	AM 5046	TM16 XS	119 mm Ø est. Ø out.	P-V8	O-ring verticali Vertical O-ring	24V	R404	Senza olio Without oil
	AM 5047	TM16 XS	132 mm Ø est. Ø out.	2 "A"	O-ring verticali Vertical O-ring	12V	R404	Senza olio Without oil
	AM 5048	TM16 XS	119 mm Ø est. Ø out.	P-V8	O-ring verticali Vertical O-ring	12V	R404	Senza olio Without oil

Qualsiasi altro modello disponibile su richiesta - Every other model available upon request

COMPRESSORI VALEO TM21 (EX SELTEC - ZEXEL)

VALEO TM21 Compressors (ex SELTEC - ZEXEL)

TM21 - TM21

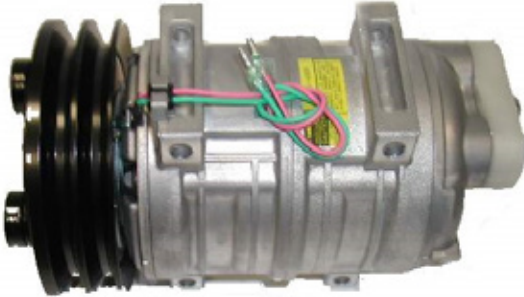

ORIGINAL "Made in Japan"

TM21

Dati Tecnici / Technical Data



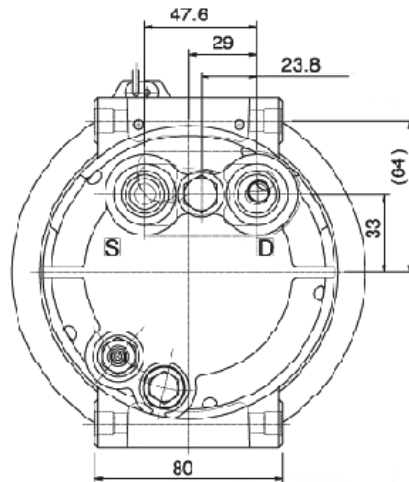
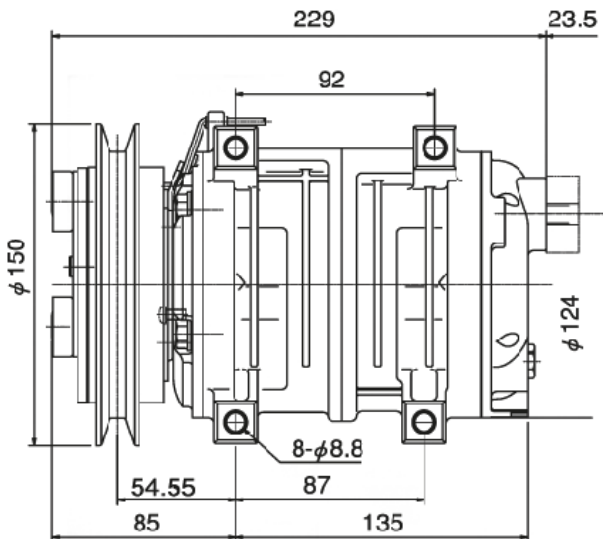

Cilindrata Displacement	214,7 cc
Numero Cilindri No. of Cylinders	10
Refrigerante Refrigerant	R134a
Tipo Olio Oil Type	ZXL 100PG (or Equiv.) PAG 46 AM 5066
Quantità Olio Oil Quantity	180 + 20 cc
Giri MAX Maximum Speed	6000 r.p.m.
Posizione di Montaggio Mounting Position	± 45°
Rotazione Rotation	Orario - Antiorario Clockwise - Counterclockwise
Raccordo Aspirazione Suction Fitting	1" 14UNS
Raccordo Mandata Discharge Fitting	1" 14UNS



COMPRESSORI VALEO TM21 (EX SELTEC - ZEXEL)

VALEO TM21 Compressors (ex SELTEC - ZEXEL)

TM21 - TM21

	Codice Code	Modello Model	Puleggia Pulley	Gole Grooves	Attacchi Fittings	Voltaggio Voltage	Gas Gas	OEM/Note OEM/Note
	AM 5024	TM21	145 mm Ø est. Ø out.	2 "A"	Flangia Flange	12V	R134	
	AM 5021	TM21	145 mm Ø est. Ø out.	2 "A"	Flangia Flange	24V	R134	
	AM 5022	TM21	141 mm Ø est. Ø out.	P-V8	Flangia Flange	12V	R134	
	AM 5025	TM21	141 mm Ø est. Ø out.	P-V8	Flangia Flange	24V	R134	488-47246
	AM 5018	TM21	150 mm Ø est. Ø out.	1 "B"	Flangia Flange	24V	R134	D085933
	AM 5039	TM21	145 mm Ø est. Ø out.	1 "A" Distanziata	Rotolock orizzontali Horizontal Rotolock	12V	R134	IVECO

Qualsiasi altro modello disponibile su richiesta - Every other model available upon request

COMPRESSORI VALEO TM31 (EX SELTEC - ZEXEL)

VALEO TM31 Compressors (ex SELTEC - ZEXEL)



TM31 - TM31



Dati Tecnici / Technical Data	
Cilindrata Displacement	310 cc
Numero Cilindri No. of Cylinders	10
Refrigerante Refrigerant	R134a
Tipo Olio Oil Type	ZXL 100PG (or Equiv.) PAG 46 AM 5066
Quantità Olio Oil Quantity	500 cc
Giri MAX Maximun Speed	5000 r.p.m.
Rotazione Rotation	Orario Clockwise 
Raccordo Aspirazione Suction Fitting	1" 1/16 14 UNF - 2A
Raccordo Mandata Discharge Fitting	7/8" 14 UNF - 2A

ORIGINAL "Made in Japan"

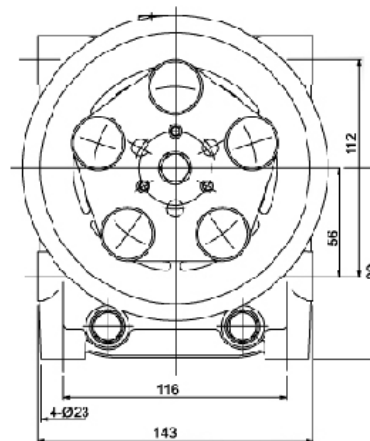
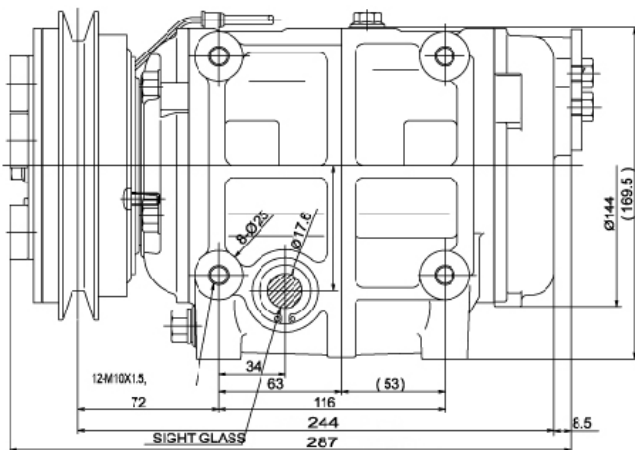

TM31





COMPRESSORI VALEO TM31 (EX SELTEC - ZEXEL)

VALEO TM31 Compressors (ex SELTEC - ZEXEL)

TM31 - TM31

	Codice Code	Modello Model	Puleggia Pulley	Gole Grooves	Attacchi Fittings	Voltaggio Voltage	Gas Gas	OEM/Note OEM/Note
	AM 5131	TM31	158 mm Ø est. Ø out.	2 "B"	O-ring orizzontali Originale Made in Japan Horizontal O-ring Original Made in Japan	24V	R134	D037440 500326851 503128488 99469367 12014 - 50155 102736 N1020633
	AM 5139	TM31	158 mm Ø est. Ø out.	P-V8	O-ring orizzontali Originale made in Japan Horizontal O-ring Original Made in Japan	24V	R134	207081R 488-46550 C.88.16.215 A C8816215A 642221 - D053295 015229 8817010000800 5010378316 12068 240103023 50182 N1020736-M
	AM 5144	TM31	153 mm Ø est. Ø out.	2 "A"	O-ring orizzontali Originale made in Japan Horizontal O-ring Original Made in Japan	24V	R134	

TM31 alternativi (PLM 32) - (PLM 32) Alternative TM31 compressors

	Codice Code	Modello Model	Puleggia Pulley	Gole Grooves	Attacchi Fittings	Voltaggio Voltage	Gas Gas	OEM/Note OEM/Note
	AM 5146	PLM 32	158 mm Ø est. Ø out.	2 "B"	O-ring orizzontali Versione alternativa Horizontal O-ring Alternative version	24V	R134	
	AM 5147	PLM 32	158 mm Ø est. Ø out.	P-V8	O-ring orizzontali Versione alternativa Horizontal O-ring Alternative version	24V	R134	

COMPRESSORI VALEO TM43 (EX SELTEC - ZEXEL)

VALEO TM43 Compressors (ex SELTEC - ZEXEL)

TM43 - TM43



Dati Tecnici / Technical Data	
Cilindrata Displacement	425 cc
Numero Cilindri No. of Cylinders	10 (5 pistoni a doppia testata)
Refrigerante Refrigerant	R134a
Tipo Olio Oil Type	ZXL 100PG (or Equiv.) PAG 46 AM 5066
Quantità Olio Oil Quantity	800 cc
Giri MAX Maximun Speed	600 - 5000 r.p.m.
Posizione di Montaggio Mounting Position	± 45°
Rotazione Rotation	Orario Clockwise 

ORIGINAL "Made in Japan"

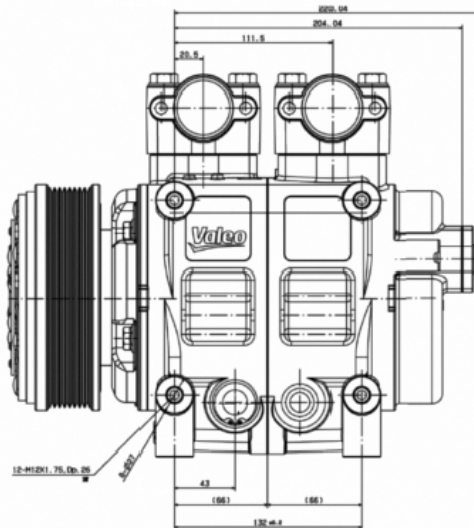
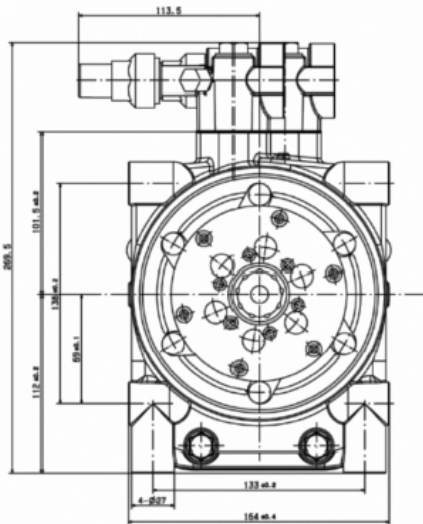

TM43



COMPRESSORI VALEO TM43 (EX SELTEC - ZEXEL)

VALEO TM43 Compressors (ex SELTEC - ZEXEL)

TM43 - TM43

	Codice Code	Modello Model	Puleggia Pulley	Gole Grooves	Voltaggio Voltage	Gas Gas	OEM/Note OEM/Note
	AM 7700	TM43	180 mm Ø est. Ø out.	2 "B"	24V	R134	
	AM 7701	TM43	156 mm Ø est. Ø out.	8 PK	24V	R134	

COMPRESSORI VALEO TM55 (EX SELTEC - ZEXEL)

VALEO TM55 Compressors (ex SELTEC - ZEXEL)

TM55 - TM55



Dati Tecnici / Technical Data	
Cilindrata Displacement	550 cc
Numero Cilindri No. of Cylinders	14 (7 pistoni a doppia testata)
Refrigerante Refrigerant	R134a
Tipo Olio Oil Type	ZXL 100PG (or Equiv.) PAG 46 AM 5066
Quantità Olio Oil Quantity	1500 cc
Giri MAX Maximum Speed	600 - 4000 r.p.m.
Posizione di Montaggio Mounting Position	± 45°
Rotazione Rotation	Orario Clockwise 

ORIGINAL "Made in Japan"

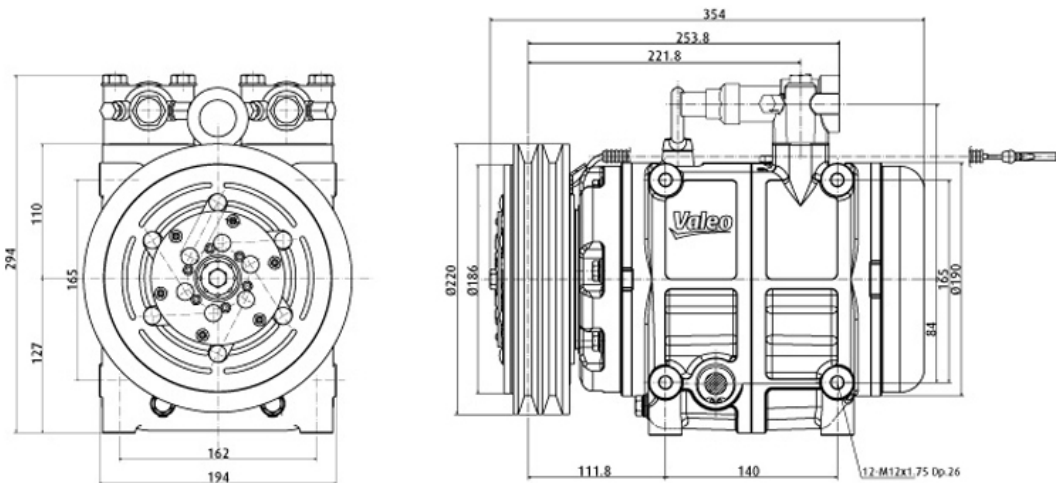

TM55





COMPRESSORI VALEO TM55 (EX SELTEC - ZEXEL)

VALEO TM55 Compressors (ex SELTEC - ZEXEL)

TM55 - TM55

	Codice Code	Modello Model	Puleggia Pulley	Gole Grooves	Attacchi Fittings	Voltaggio Voltage	Gas Gas	OEM/Note OEM/Note
	AM 7702	TM55	220 mm Ø est. Ø out.	2 "B"	Flangia Flange	24V	R134	
	AM 7703	TM55	"A" 200 mm "B" 240 mm Ø est. Ø out.	2 "A" 2 "B"	Flangia Flange	24V	R134	
	AM 7704	TM55	196 mm Ø est. Ø out.	P-V8	Flangia Flange	24V	R134	

Bobina frizione TM55 - TM55 Coil

	Codice Code	Modello Model	Puleggia Pulley	Gole Grooves	Attacchi Fittings	Voltaggio Voltage	Gas Gas	OEM/Note OEM/Note
	AM 7620	TM 55/65	196 mm Ø est. Ø out.	P-V8		24V		
	AM 7802	TM 55/65	158,6 mm Ø est. Ø out.					

COMPRESSORI VALEO TM65 (EX SELTEC - ZEXEL)

VALEO TM65 Compressors (ex SELTEC - ZEXEL)

TM65 - TM65



Dati Tecnici / Technical Data	
Cilindrata Displacement	635 cc
Numero Cilindri No. of Cylinders	14 (7 pistoni a doppia testata)
Refrigerante Refrigerant	R134a
Tipo Olio Oil Type	ZXL 100PG (or Equiv.) PAG 46 AM 5066
Quantità Olio Oil Quantity	1500 cc
Giri MAX Maximum Speed	600 - 4000 r.p.m.
Posizione di Montaggio Mounting Position	± 45°
Rotazione Rotation	Orario Clockwise 

ORIGINAL "Made in Japan"



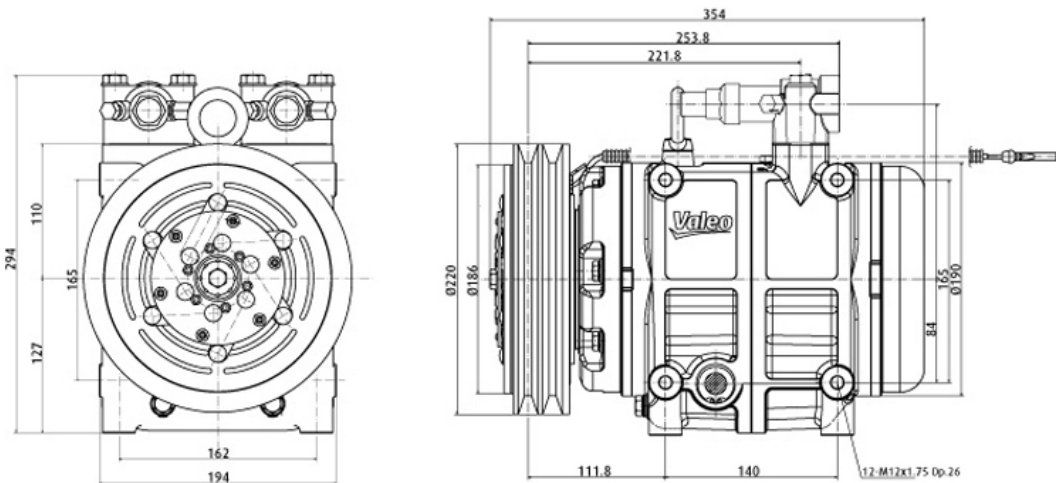

TM65





COMPRESSORI VALEO TM65 (EX SELTEC - ZEXEL)

VALEO TM65 Compressors (ex SELTEC - ZEXEL)

TM65 - TM65

	Codice Code	Modello Model	Puleggia Pulley	Gole Grooves	Attacchi Fittings	Voltaggio Voltage	Gas Gas	OEM/Note OEM/Note
	AM 7705	TM65	220 mm Ø est. Ø out.	2 "B"	Flangia Flange	24V	R134	
	AM 7706	TM65	"A" 240 mm "B" 200 mm Ø est. Ø out.	2 "A" 2 "B"	Flangia Flange	24V	R134	
	AM 7707	TM65	196 mm Ø est. Ø out.	P-V8	Flangia Flange	24V	R134	
	AM 7708	TM65	204 mm Ø est. Ø out.	2 "B"	Flangia Flange			
	AM 7709	TM65	180 mm Ø est. Ø out.	P-V10	Flangia Flange			36779706074

Bobina frizione TM65 - TM65 Coil

	Codice Code	Modello Model	Puleggia Pulley	Gole Grooves	Attacchi Fittings	Voltaggio Voltage	Gas Gas	OEM/Note OEM/Note
	AM 7620	TM 55/65	196 mm Ø est. Ø out.	P-V8		24V		
	AM 7802	TM 55/65	158,6 mm Ø est. Ø out.					

RICAMBI COMPRESSORI VALEO

Valeo Compressors spare parts

Ricambi TM15/TM16 - TM15/TM16 Spare parts

	Codice Code	Applicazione Application	Descrizione Description	OEM/Note OEM/Note
	AM 51143	TM15/TM16	Attacco O-ring Verticale Vertical O-ring	
	AM 51144	TM15/TM16	Attacco O-ring Orizzontale Horizontal O-ring	
	AM 51146	TM15/TM16	Attacco Rotolock Orizzontale Horizontal O-ring	
	AM 51147	TM15/16	Attacco Rotolock Orizzontale Horizontal O-ring	
	AM 5215	TM15/16 26 mm Ø est/out 15 mm Ø int/ins 11 mm H	Premistoppa Shaft seal	
	AM 5216	DK15 25 mm Ø est/out 14 mm Ø int/ins 15 mm H	Premistoppa Shaft seal	

RICAMBI COMPRESSORI VALEO

Valeo Compressors spare parts

Elettrofrizioni DK/DKS/TM15/TM16 - Electromagnetics clutch DK/DKS/TM15/TM16

	Codice Code	Applicazione Application	Descrizione Description	OEM/Note OEM/Note
	AM 5330	TM08/TM13/TM14/TM15/TM16	Elettrofrizione 2 gole A Ø 132 mm 12V Electromagnetic clutch 2 gr. A Ø 132 12V	
	AM 5231	TM08/TM13/TM14/TM15/TM16	Elettrofrizione 2 gole A Ø 125 mm 24V Electromagnetic clutch 2 gr. A Ø 125 mm 24V	
	AM 5226	TM08/TM13/TM14/TM15/TM16	Elettrofrizione 2 gole A Ø 132 mm 24V Electromagnetic clutch 2 gr. A Ø 132 mm 24V	506013600
	AM 5224	TM08/TM13/TM14/TM15/TM16	Elettrofrizione Poly-V8 Ø 119 mm 12V Electromagnetic clutch Poly-V8 Ø 119 mm 12V	
	AM 5328	TM08/TM13/TM14/TM15/TM16	Elettrofrizione Poly-V8 Ø. 119 mm 24V Electromagnetic clutch Poly-V8 Ø 119 mm 24V	
	AM 5234	TM08/TM13/TM14/TM15/TM16	Elettrofrizione Poly-V6 Ø 119 mm 12V Electromagnetic clutch Poly-V6 Ø 119 mm V12	
	AM 5267	TM15/TM16	Puleggia 1 gola A Ø 150 mm Pulley 1 gr. A Ø 150 mm	
	AM 5265	TM08/13/15/16 Per 2 gole A Ø. 125 mm For 2 gr. A Ø. 125 mm	Bobina 12V Coil 12V	
	AM 5266	TM08/13/15/16 Per 2 gole A Ø. 132 mm Poly-V Ø 120 mm For 2 gr. A Ø. 125 mm Poly-V Ø 120 mm	Bobina 12V Coil 12V	

RICAMBI COMPRESSORI VALEO

Valeo Compressors spare parts

Ricambi DK/DKS/TM26 - DKS32/TM31/TM32 - DK/DKS/TM26 - DKS32/TM31/TM32 Spare parts

	Codice Code	Applicazione Application	Descrizione Description	OEM/Note OEM/Note
	AM 5133	DKS32/TM31 32 mm Ø est/out 18 mm Ø int/ins 15 mm H	Premistoppa e guarnizioni Shaft seal kit and gaskets	
	AM 5225	DK26/TM26	AD ESAURIMENTO Premistoppa Shaft seal kit	
	AM 5148	DK/DKS26	Cuscinetto Bearing	
	AM 5143	DKS32/TM31	Cuscinetto Bearing	
	AM 5138	TM31	Kit adattatori da DK26 a TM31 Adapter kit	
	AM OR5201	TM31	O-ring spia liquido O-ring for sigh glass	
	AM OR5048	TM31	O-ring basamento attacchi O-ring for shut of valve	
	AM 3340	TM31	Kit coppia rubinetti con predisposizione pressostato Shut off valve kit	
	AM 5150	TM31	Tappo valvola BP attacchi Low pressure cap	
	AM 5151	TM31	Tappo valvola AP attacchi High pressure cap	

RICAMBI COMPRESSORI VALEO

Valeo compressors spare parts

Elettrofrizioni TM21

Electromagnetics clutch TM21

	Codice Code	Applicazione Application	Descrizione Description	OEM/Note OEM/Note
	AM 5245	TM21	Elettrofrizione 2 gole A Ø 145mm 24V Electromagnetic clutch 2 gr. A Ø 145 mm 24V	
	AM 5242	TM21	Elettrofrizione Poly-V8 Ø 137 mm 24V Electromagnetic clutch Poly-V8 Ø 137 mm 24V	
	AM 5249	TM21	Elettrofrizione 1 gola B Ø 150 mm 24V Electromagnetic clutch 1 gr B Ø 150 mm 24V	
	AM 5252	TM21	Puleggia Poly-V5 Ø 125 mm Pulley Poly-V5 Ø 125 mm	Applicazione speciale
	AM 7580	TM21	Puleggia 1 gola A Ø 150 mm Pulley 1 gr. A Ø 150 mm	Per Daily 3.0 "Ind car"
	AM 5244	TM21	Bobina 24V Coil 24V	

Elettrofrizioni DK/DKS/TM26 - DK/DKS32/TM31



Electromagnetics clutch DK/DKS/TM26 - DK/DKS32/TM31

	Codice Code	Applicazione Application	Descrizione Description	OEM/Note OEM/Note
	AM 5132	DKS32/TM31	Elettrofrizione 2 gole B Ø 158 mm 24V Electromagnetic clutch 2 gr. B Ø 158 mm 24V	42533969 - 8010001827
	AM 5145	DKS32/TM31	Elettrofrizione Poly-V8 Ø 156 mm 24V Electromagnetic clutch Poly-V8 Ø 156 mm 24V	



RICAMBI COMPRESSORI VALEO

Valeo compressors spare parts

Elettrofrizioni TM55/TM65 - TM55/TM65 Electromagnetics clutch

	Codice Code	Modello Model	Puleggia Pulley	Gole Grooves	Attacchi Fittings	Voltaggio Voltage	Gas Gas	OEM/Note OEM/Note
	AM 7620	TM 55/65	196 mm Ø est. Ø out.	P-V8		24V		
	AM 7802	TM 55/65	158,6 mm Ø est. Ø out.					

Ricambi TM43//TM55/TM65 - TM43/TM55/TM65 Spare parts

	Codice Code	Applicazione Application	Descrizione Description	OEM/Note OEM/Note
	AM 3341	TM43/TM55/TM65	Kit coppia rubinetti Shut off valve kit	
	AM 3342	TM55/TM65	Kit premistoppa Shaft seal kit	

COMPRESSORI GEA BOCK

Gea Bock Compressors



Tabella informativa ingombri e dimensioni - Dimensions table

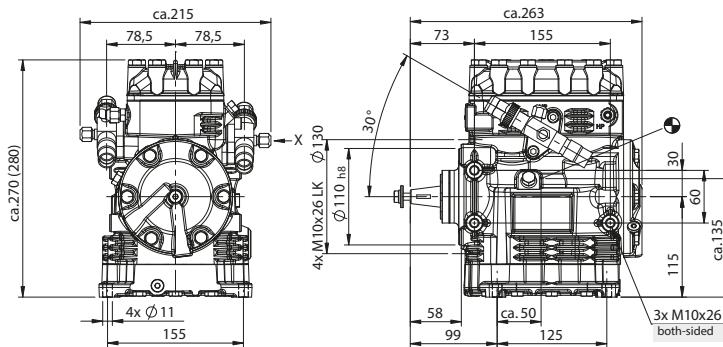

Modello Model	Peso Weight
FKX20 sostituisce FK2 - FKX2 Replace FK2 - FKX2	15 Kg

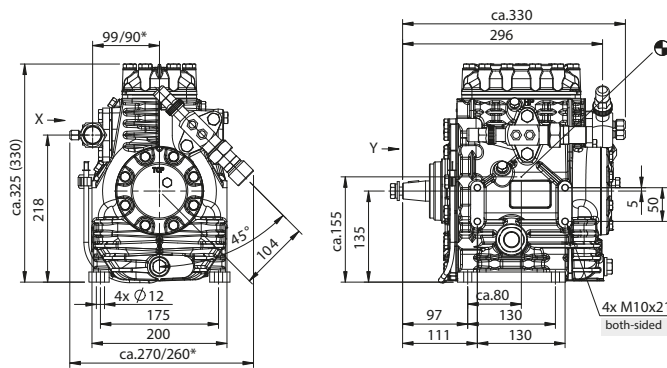

Modello Model	Peso Weight
FKX30 sostituisce FK3 - FKX23 Replace FK2 - FKX2	26 Kg

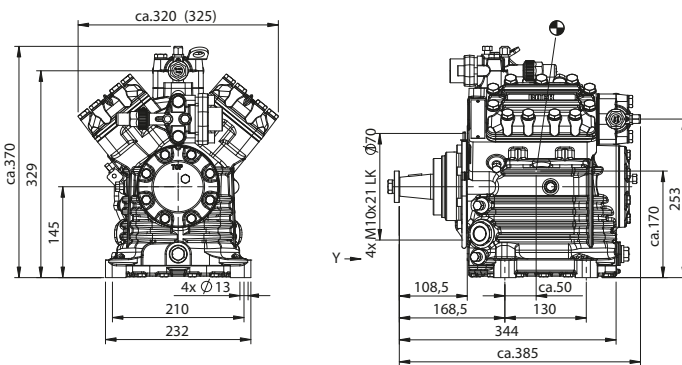

Modello Model	Peso Weight
FKX40 sostituisce FK4 - FKX4/467A Replace FK4 - FKX4/467A	35 Kg

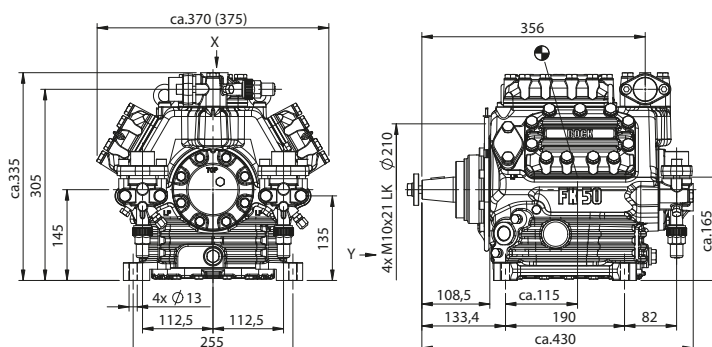

Modello Model	Peso Weight
FKX50 sostituisce FK5 - FKX26 Replace FK5 - FKX26	43 Kg

COMPRESSORI GEA BOCK

Gea Bock Compressors



Tabella informativa ingombri e dimensioni

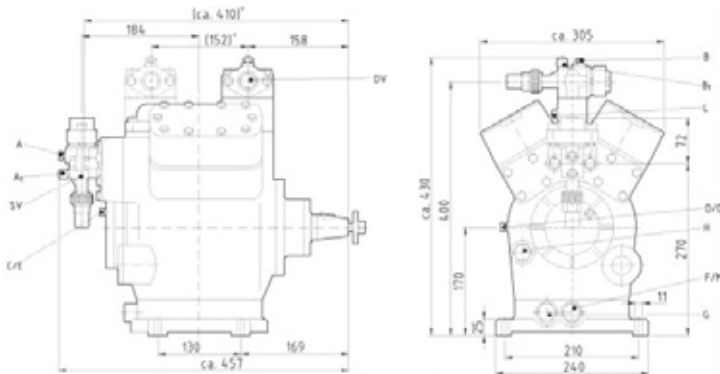

FUORI PRODUZIONE
Availability: out of production

Modello
Model

FK4
Sostituito da FKX40
Replaced by FKX40

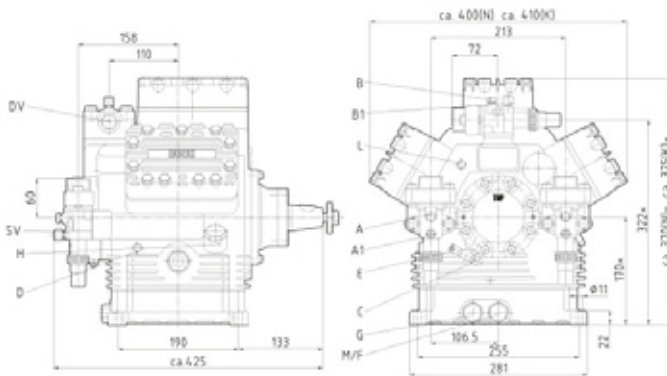

FUORI PRODUZIONE
Availability: out of production

Modello
Model

FK26
Sostituibile da FKX50
Replaced by FKX50



Tabella sostitutiva vecchia gamma

	Vecchi Modelli Old models	Sostituito da Replaced by	Quantità Olio Oil quantity	Codice Olio Oil code
COMPRESSORI GEA - BOCK FUORI PRODUZIONE O AD ESAURIMENTO	FK2 - FKX2	FKX20	FUCHS SE 55 - L 0,8	AM 5105 (L 1) AM 5098 (L 5)
	FK3 - FKX3	FKX30	FUCHS SE 55 - L 1,5	
	FK4 - FKX4/467	FKX40	FUCHS SE 55 - L 2,6	
	FKX26	FKX50	FUCHS SE 55 - L 3,3	

RICAMBI COMPRESSORE GEA BOCK DI MAGGIOR CONSUMO

Compressors spare parts

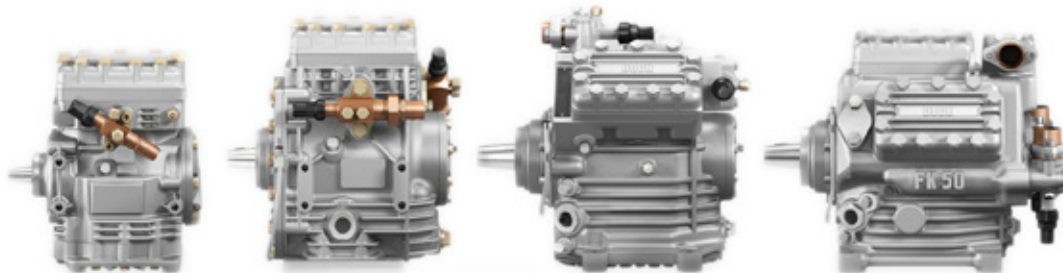

Premistoppa - Shaft seal

Codice Code	AM 6403	AM 6400	AM 6401	AM 6402
Applicazione Application	FKX30	FKX40/50	FKX4/467 -FK4/5	FKX26

Guarnizioni - Gaskets

Codice Code	KO H99980000	KO H99980001	KO H99908700	KO H99908720	KO H99908071
Applicazione Application	FKX40/470N 555N/650N	FKX40/470K 555K/650K	FKX26/470N 550N/670N	FKX26/470K 550K/670K	FK4

Codice Code	KO H99908072	KO H99980089	KO H99905067 / H99905067G	KO H99905083
Applicazione Application	FK5	FK50 K	Tutti i modelli - All models	Tutti i modelli - All models

RICAMBI COMPRESSORE GEA BOCK DI MAGGIOR CONSUMO



Compressors spare parts



Rubinetti - Shut-off valves

				
Codice Code	KO H99907128	KO H99908082	KO H99908084	AM 5476
Applicazione Application	FK4/FKX40/FK26	FK4/FKX40/FK26	FK4/FKX40/FK26	Tutti i modelli - <i>All models</i>
Descrizione Description	Rubinetto senza flangia <i>Without flanges</i>	Rubinetto con flangia -BP <i>With flanges</i>	Rubinetto con flangia - AP <i>With flanges</i>	

Olio - Oil

		
Codice Code	AM 5105	AM 5098
Applicazione Application	Tutti i modelli - <i>All models</i>	Tutti i modelli - <i>All models</i>
Descrizione Description	L 1 Olio Fuchs Triton SE 55 <i>Fuchs Triton SE 55 oil</i>	L 5 Olio Fuchs Triton SE 55 <i>Fuchs Triton SE 55 oil</i>

COMPRESSORI GEA BOCK FKX20

Gea Bock FKX20 Compressors



FKX20



FKX20

Dati Tecnici / Technical Data

Cilindrata Displacement	Varianti: 118/143/170
Numero Cilindri No. of Cylinders	2
Refrigerante Refrigerant	R134a/R404A/R407CF/R507/R22
Tipo Olio Oil Type	Reniso Triton SE 55 (o Equiv.) N.B. per gas R22 Reniso SP 46 (o Equiv.)
Quantità Olio Oil Quantity	700 cc
Giri MAX Maximun Speed	3000 r.p.m. (serie "N") 2600 r.p.m. (serie "K")
Inclinazione MAX Maximun Inclination	15°
Raccordo Aspirazione Suction Fitting	16 mm - 5/8 "
Raccordo Mandata Discharge Fitting	16 mm - 5/8 "

Codice Code	Descrizione Description	Cilindrata Displacement	Quantità Olio Oil quantity	Codice Olio Oil code	OEM/Note OEM/Note
AM 7476	FKX20/120TK	118 cc	FUCHS SE 55 - L 0,7	AM 5105 (L 1) AM 5098 (L 5)	Per refrigerazione For refrigeration
	FKX20/145TK	143 cc	FUCHS SE 55 - L 0,7	AM 5105 (L 1) AM 5098 (L 5)	Per refrigerazione For refrigeration
AM 7556	FKX20/170TK	170 cc	FUCHS SE 55 - L 0,7	AM 5105 (L 1) AM 5098 (L 5)	Per refrigerazione For refrigeration

COMPRESSORI GEA BOCK FKX30

Gea Bock FKX30 Compressors



FKX30 - FKX30



FKX30

Dati Tecnici / Technical Data

Cilindrata Displacement	Varianti: 235/275/325
Numero Cilindri No. of Cylinders	2
Refrigerante Refrigerant	R134a/R404A/R407CF/R507/R22
Tipo Olio Oil Type	Reniso Triton SE 55 (o Equiv.) N.B. per gas R22 Reniso SP 46 (o Equiv.)
Quantità Olio Oil Quantity	2000 cc
Giri MAX Maximun Speed	3000 r.p.m. (serie "N") 2600 r.p.m. (serie "K")
Inclinazione MAX Maximun Inclination	15°
Raccordo Aspirazione Suction Fitting	22 mm - 7/8 "
Raccordo Mandata Discharge Fitting	16 mm - 5/8 "

Codice Code	Descrizione Description	Cilindrata Displacement	Quantità Olio Oil quantity	Codice Olio Oil code	OEM/Note OEM/Note
	FKX30/235N	235 cc	FUCHS SE 55 - L 2	AM 5105 (L 1) AM 5098 (L 5)	
AM 7446	FKX30/235K	235 cc	FUCHS SE 55 - L 2	AM 5105 (L 1) AM 5098 (L 5)	
AM 7564	FKX30/235TK	235 cc	FUCHS SE 55 - L 2	AM 5105 (L 1) AM 5098 (L 5)	Per refrigerazione For refrigeration
	FKX30/275N	275 cc	FUCHS SE 55 - L 2	AM 5105 (L 1) AM 5098 (L 5)	
	FKX30/275K	275 cc	FUCHS SE 55 - L 2	AM 5105 (L 1) AM 5098 (L 5)	
	FKX30/325N	325 cc	FUCHS SE 55 - L 2	AM 5105 (L 1) AM 5098 (L 5)	
AM 7440	FKX30/325K	325 cc	FUCHS SE 55 - L 2	AM 5105 (L 1) AM 5098 (L 5)	A002860
AM 7562	FKX30/325TK	325 cc	FUCHS SE 55 - L 2	AM 5105 (L 1) AM 5098 (L 5)	Per refrigerazione For refrigeration

Posizione Position	FKX30		Descrizione Description	OEM/Note OEM/Note
50		KO H99905695	Guarnizione inferiore piastra valvole Versione N - Ø 55 mm Gasket - Lower valve plate Version N - Ø 55 mm	
50		KO H99905696	Guarnizione inferiore piastra valvole Versione N - Ø 60 mm Gasket - Lower valve plate Version N - Ø 60 mm	





COMPRESSORI GEA BOCK FKX30

Gea Bock FKX30 Compressors

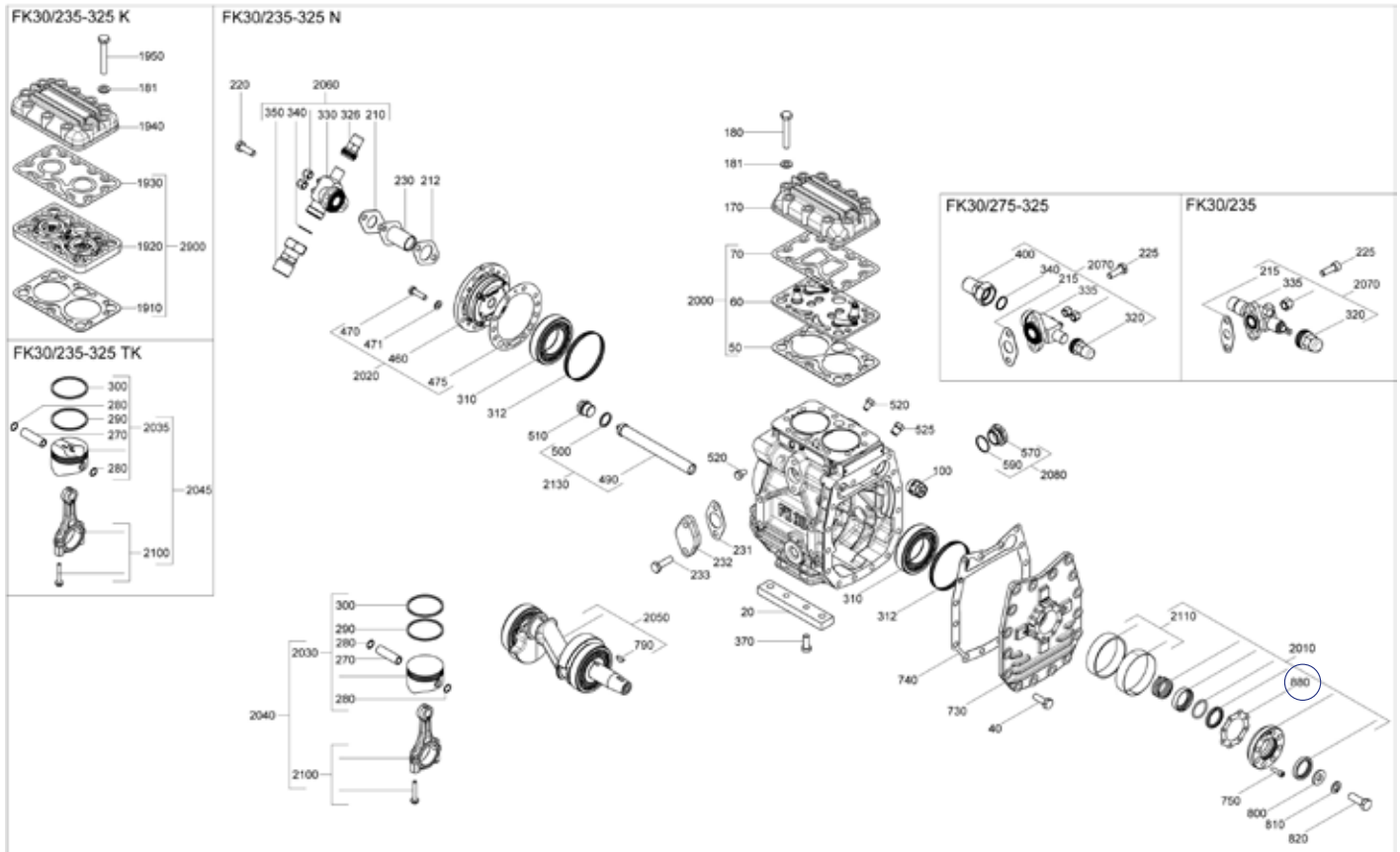

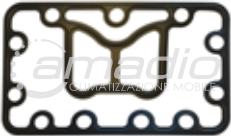
FKX30 - FKX30

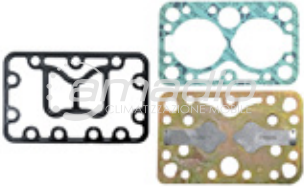

Posizione Position	FKX30	Descrizione Description	OEM/Note OEM/Note
70	 KO H99906730	Guarnizione superiore piastra valvole Versione N Gasket valve plate bottom Version N	
50	 KO H99905697	Guarnizione inferiore piastra valvole Versione N - Ø 65 mm Gasket - Lower valve plate Version N - Ø 65 mm	
2000	 KO H99980240	Kit piastra valvole Versione N - Ø 60 mm Set-valve plate Version N - Ø 60 mm	
2000	 KO H99980241	Kit piastra valvole Versione N - Ø 65 mm Set-valve plate Version N - Ø 65 mm	
2010	 AM 6403	Premistoppa Set-shaft seal	A0008302798

RICAMBI COMPRESSORE BOCK FK4 - FKX4/467

BOCK FK4 - FKX4/467 Compressors spare parts



FUORI PRODUZIONE
Availability: out of production

Modello
Model

FK4
Sostituito da FKX40
Replaced by FKX40

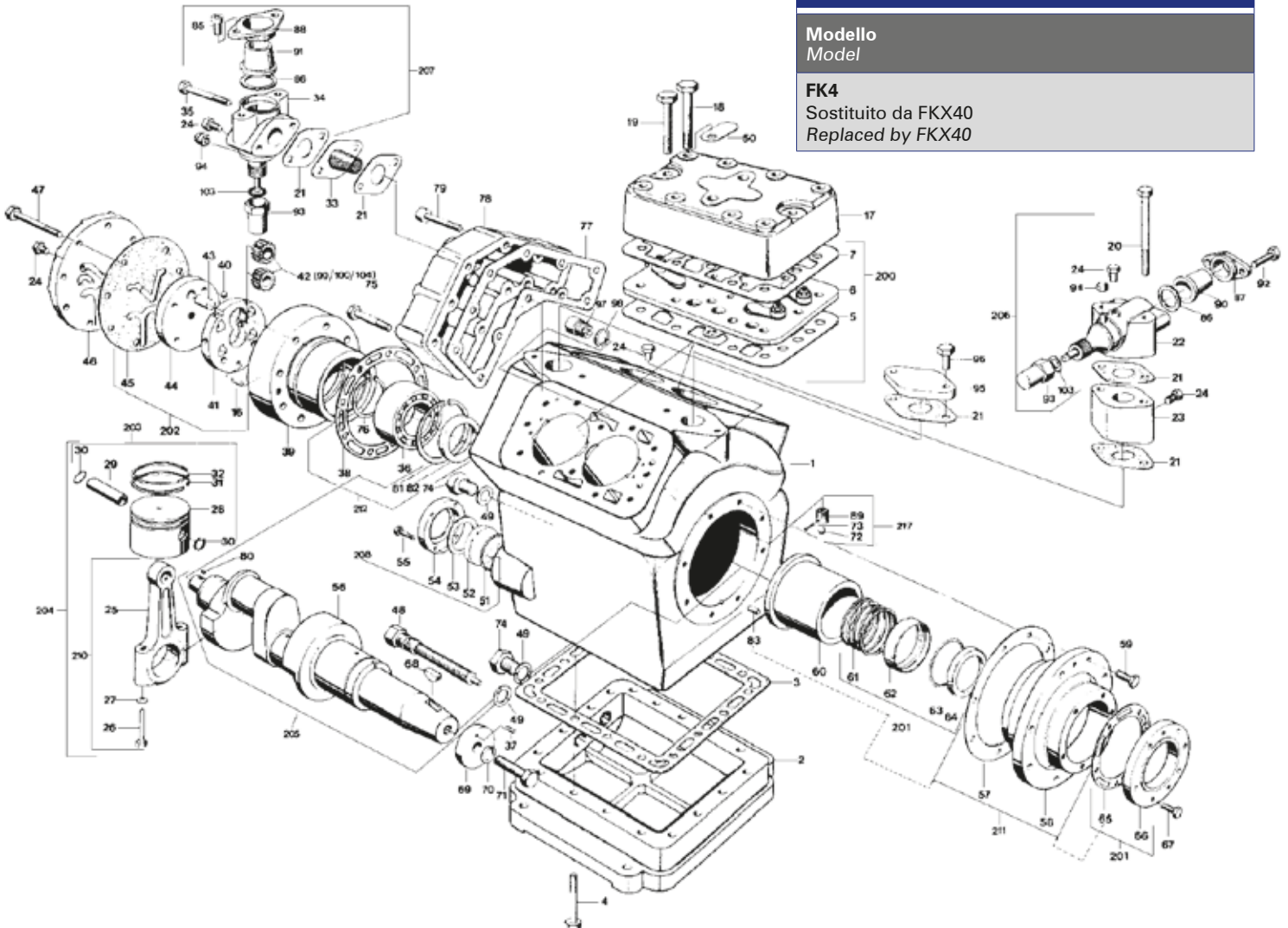

Posizione Position	FK4	FKX4/467A	Descrizione Description
	AM 5105	AM 5105	L 1 - Olio Fuchs Triton SE 55 - Fuchs Triton SE 55 oil
	AM 5098	AM 5098	L 5 - Olio Fuchs Triton SE 55 - Fuchs Triton SE 55 oil
3	KO H99905046	-----	Guarnizione coppa olio Oil sump gasket
5	KO H99905028	KO H99905028	Guarnizione inferiore piastra valvole Gasket - Lower valve plate
7	KO H99905010	KO H99905010	Guarnizione superiore piastra valvole Gasket - Upper valve plate
21	KO H99905083	KO H99905083	Guarnizione ovale Oval gasket
22-34	KO H99907128	KO H99907128	Rubinetto senza flangie Valve without flange
33	KO H99903370	KO H99903370	Filtro aspirazione Suction filter

RICAMBI COMPRESSORE BOCK FK4 - FKX4/467

BOCK FK4 - FKX4/467 Compressors spare parts













Posizione Position	FK4	FKX4/467A	Descrizione Description
36	KO H99907257 *	KO H99907755	Cuscinetto anteriore/posteriore - * solo posteriore Front/rear bearing - * rear only
40	KO H99905566	KO H99905566	Sfera - Sphere
48	KO H99904442	KO H99904442	Filtro olio - Oil filter
49	KO H99905342	KO H99905342	Anello di tenuta 27x22x2 Seal ring 27x22x2
57	KO H99905058	-----	Guarnizione flangia - Gasket valve flange
60	KO H99904359	-----	Boccola - Bushing
68	KO H99905673	KO H99905673	Chiavetta A5X9 Key A5x9
80	KO H99905670	KO H99905670	Chiavetta A3x3.7 Key A3x3.7
86	KO H99905067	KO H99905067	Guarnizione 42x34 mm - Spessore 1 mm Gasket - 1 mm thickness
86	KO H99905067G	KO H99905067G	Guarnizione 42x34 mm - Spessore 2 mm Gasket - 2 mm thickness
93	KO H99905784	KO H99905784	Tappo per rubinetto Tap's cap for valve
200 (comprende 5/6/7)	KO H99908198	KO H99908198	Kit piastra valvole Valve plate kit
201 (comprende 61/62/63 64/65/66/67)	AM 6401	AM 6401	Kit premistoppa Shaft seal kit
202 (comprende 16/41/44/45)	KO H99908044	KO H99908044	Kit pompa olio Oil pump kit
203 (comprende 28/29/30/31/32)	KO H99980103	KO H99980103	Kit pistone Piston kit
205 (comprende 56/68/80)	KO H99908055	KO H99908055	Kit albero Compressor shaft kit
210 (comprende 25/26)	KO H99908304	KO H99908449	Kit biella Compressor connecting rod kit
211 (comprende 57/58/60/65/83)	KO H99908158	-----	Kit tenuta cuscinetto anteriore Front bearing gasket kit
212 (comprende 36/38/76/81/82)	KO H99908104	-----	Kit cuscinetto posteriore Rear bearing kit
217 (comprende 89/73/72)	KO H99908111	KO H99908111	Kit bussola Compass kit
... (comprende 3/5/7/21/38/45/49/57/65/77 /86/98)	KO H99908071	KO H99908071	Kit guarnizioni completo Gasket kit
ACCESSORI ED ATTREZZATURA - ACCESSORIES AND TOOLS			
	KO H99908603	KO H99908603	Kit parzializzatore Capacity regulator kit
	KO H99980022	KO H99980022	Kit adattatore rubinetti da FK4 a FKX40 Set-replacement adapter set the same shut-off valve
	AM 5476	AM 5476	Chiave regolazione rubinetti Straight ratchet wrenche
RUBINETTI - VALVE			
22/34	KO H99907128	KO H99907128	Rubinetto universale senza flangia Valve without flange
206	KO H99908084	KO H99908084	Rubinetto mandata con flangia AP H.P. valve with flange
207	KO H99908082	KO H99908082	Rubinetto aspirazione con flangia BP L.P. valve with flange

RICAMBI COMPRESSORE BOCK FK4 - FKX4/467

BOCK FK4 - FKX4/467 Compressors spare parts



Posizione Position		FK4	FKX4/467A	Descrizione Description	OEM/Note OEM/Note
		AM 5105	AM 5105	L 1 Olio Fuchs Triton SE 55 Fuchs Triton SE 55 oil	
		AM 5098	AM 5098	L 5 Olio Fuchs Triton SE 55 Fuchs Triton SE 55 oil	
3		KO H99905046	-----	Guarnizione coppa olio Oil sump gasket	
5		KO H99905028	KO H99905028	Guarnizione inferiore piastra valvole Gasket - Lower valve plate	
7		KO H99905010	KO H99905010	Guarnizione superiore piastra valvole Gasket - Upper valve plate	
21		KO H99905083	KO H99905083	Guarnizione ovale Oval gasket	
33		KO H99903370	KO H99903370	Filtro aspirazione Suction filter	
36		KO H99907257 *	KO H99907755	Cuscinetto anteriore/posteriore - * solo posteriore Front/rear bearing - * rear only	
40		KO H99905566	KO H99905566	Sfera - Sphere	
48		KO H99904442	KO H99904442	Filtro olio - Oil filter	

RICAMBI COMPRESSORE BOCK FK4 - FKX4/467

BOCK FK4 - FKX4/467 Compressors spare parts





Posizione Position		FK4	FKX4/467A	Descrizione Description	OEM/Note OEM/Note
49		KO H99905342	KO H99905342	Anello di tenuta 27x22x2 Seal ring 27x22x2	
57		KO H99905058	-----	Guarnizione flangia Gasket valve flange	
60		KO H99904359	-----	Boccola Bushing	
68		KO H99905673	KO H99905673	Chiavetta A5X9 Key A5x9	
80		KO H99905670	KO H99905670	Chiavetta A3x3.7 Key A3x3.7	
86		KO H99905067	KO H99905067	Guarnizione 42x34 mm Spessore 1 mm Gasket 1 mm thickness	
		KO H99905067G	KO H99905067G	Guarnizione 42x34 mm Spessore 2 mm Gasket 2 mm thickness	
93		KO H99905784	KO H99905784	Tappo per rubinetto Tap's cap for valve	
200 (comprende 5/6/7)		KO H99908198	KO H99908198	Kit piastra valvole Valve plate kit	
201 (comprende 61/62/63 64/65 66/67)		AM 6401	AM 6401	Kit premistoppa Shaft seal kit	

RICAMBI COMPRESSORE BOCK FK4 - FKX4/467

BOCK FK4 - FKX4/467 Compressors spare parts









Posizione Position		FK4	FKX4/467A	Descrizione Description	OEM/Note OEM/Note
202 (comprende 16/41 44/45)		KO H99908044	KO H99908044	Kit pompa olio Oil pump kit	
203 (comprende 28/29 30/31/32)		KO H99980103	KO H99980103	Kit pistone Piston kit	
205 (comprende 56/68/80)		KO H99908055	KO H99908055	Kit albero Compressor shaft kit	
210 (comprende 25/26)		KO H99908304	KO H99981293	Kit biella Compressor connecting rod kit	
211 (comprende 56/58/60 65/83)		KO H99908158	-----	Kit tenuta cuscinetto anteriore Front bearing gasket kit	
212 (comprende 36/38/76 81/82)		KO H99908104	-----	Kit cuscinetto posteriore Rear bearing kit	
217 (comprende 89/73/72)		KO H99908111	KO H99908111	Kit bussola Compass kit	
... (comprende 3/5/7/21/38/45 /49/57/65/77/8 6/98)		KO H99908071	KO H99908071	Kit guarnizioni completo Gasket kit	

RICAMBI COMPRESSORE BOCK FK4 - FKX4/467

BOCK FK4 - FKX4/467 Compressors spare parts



Posizione Position	FK4	FKX4/467A	Descrizione Description	OEM/Note OEM/Note
ACCESSORI ED ATTREZZATURA - ACCESSORIES AND TOOLS				
		KO H99908603	KO H99908603	Kit parzializzatore Capacity regulator kit
		KO H99980022	KO H99980022	Kit adattatore rubinetti da FK4 a FKX40 Set-replacement adapter set the same shut-off valve
		AM 5476	AM 5476	Chiave regolazione rubinetti Straight ratchet wrenche
RUBINETTI - SHUT-OFF VALVES				
22/34		KO H99907128	KO H99907128	Rubinetto universale senza flangia Valve without flange
206		KO H99908084	KO H99908084	Rubinetto mandata con flangia AP H.P. valve with flange
207		KO H99908082	KO H99908082	Rubinetto aspirazione con flangia BP L.P. valve with flange

COMPRESSORI GEA BOCK FKX40

Gea Bock FKX40 Compressors

FKX40 - FKX40



Dati Tecnici / Technical Data	
Cilindrata Displacement	Varianti: 390/470/560/655
Numero Cilindri No. of Cylinders	4
Refrigerante Refrigerant	R134a/R404A/R407CF/R507/R22
Tipo Olio Oil Type	Reniso Triton SE 55 (o Equiv.) N.B. per gas R22 Reniso SP 46 (o Equiv.)
Quantità Olio Oil Quantity	2000 cc
Giri MAX Maximun Speed	3000 r.p.m. (serie "N") 2600 r.p.m. (serie "K")
Inclinazione MAX Maximun Inclination	15°
Raccordo Aspirazione Suction Fitting	26 mm - 1 1/8 "
Raccordo Mandata Discharge Fitting	22 mm - 7/8 "

SENZA FLANGE / Without flanges

	Codice Code	Descrizione Description	Cilindrata Displacement	Quantità Olio Oil quantity	Codice Olio Oil code	OEM/Note OEM/Note
	AM 7401SF	FKX40/470N	465 cc	FUCHS SE 55 - LT. 2	AM 5105 (L 1) AM 5098 (L 5)	
	AM 7404SF	FKX40/470K	465 cc	FUCHS SE 55 - LT. 2	AM 5105 (L 1) AM 5098 (L 5)	
	AM 7402SF	FKX40/560N	554 cc	FUCHS SE 55 - LT. 2	AM 5105 (L 1) AM 5098 (L 5)	
	AM 7405SF	FKX40/560K	554 cc	FUCHS SE 55 - LT. 2	AM 5105 (L 1) AM 5098 (L 5)	
	AM 7407SF	FKX40/655K	650 cc	FUCHS SE 55 - LT. 2	AM 5105 (L 1) AM 5098 (L 5)	
	AM 7712SF	FKX40/775K	775 cc	FUCHS SE 55 - LT. 2	AM 5105 (L 1) AM 5098 (L 5)	

RICAMBI COMPRESSORE BOCK FK4 - FKX4/467

BOCK FK4 - FKX4/467 Compressors spare parts



SENZA RUBINETTI / Without shut-off valve

	Codice Code	Descrizione Description	Cilindrata Displacement	Quantità Olio Oil quantity	Codice Olio Oil code	OEM/Note OEM/Note
	AM 7404SR	FKX40/470K	465 cc	FUCHS SE 55 - LT. 2	AM 5105 (L 1) AM 5098 (L 5)	
	AM 7405SR	FKX40/560K	555 cc	FUCHS SE 55 - LT. 2	AM 5105 (L 1) AM 5098 (L 5)	
	AM 7407SR	FKX40/655K	650 cc	FUCHS SE 55 - LT. 2	AM 5105 (L 1) AM 5098 (L 5)	

MOTORI E6/ E6 engines

	Codice Code	Descrizione Description	Cilindrata Displacement	Quantità Olio Oil quantity	Codice Olio Oil code	OEM/Note OEM/Note
	AM 7404K1	FKX40/470K E6	466 cc	FUCHS SE 55 - LT. 2	AM 5105 (L 1) AM 5098 (L 5)	
	AM 7405K1	FKX40/560K E6	554 cc	FUCHS SE 55 - LT. 2	AM 5105 (L 1) AM 5098 (L 5)	
	AM 7407K1	FKX40/655K E6	650 cc	FUCHS SE 55 - LT. 2	AM 5105 (L 1) AM 5098 (L 5)	

RICAMBI COMPRESSORE BOCK FKX40
BOCK FKX40 Compressors spare parts

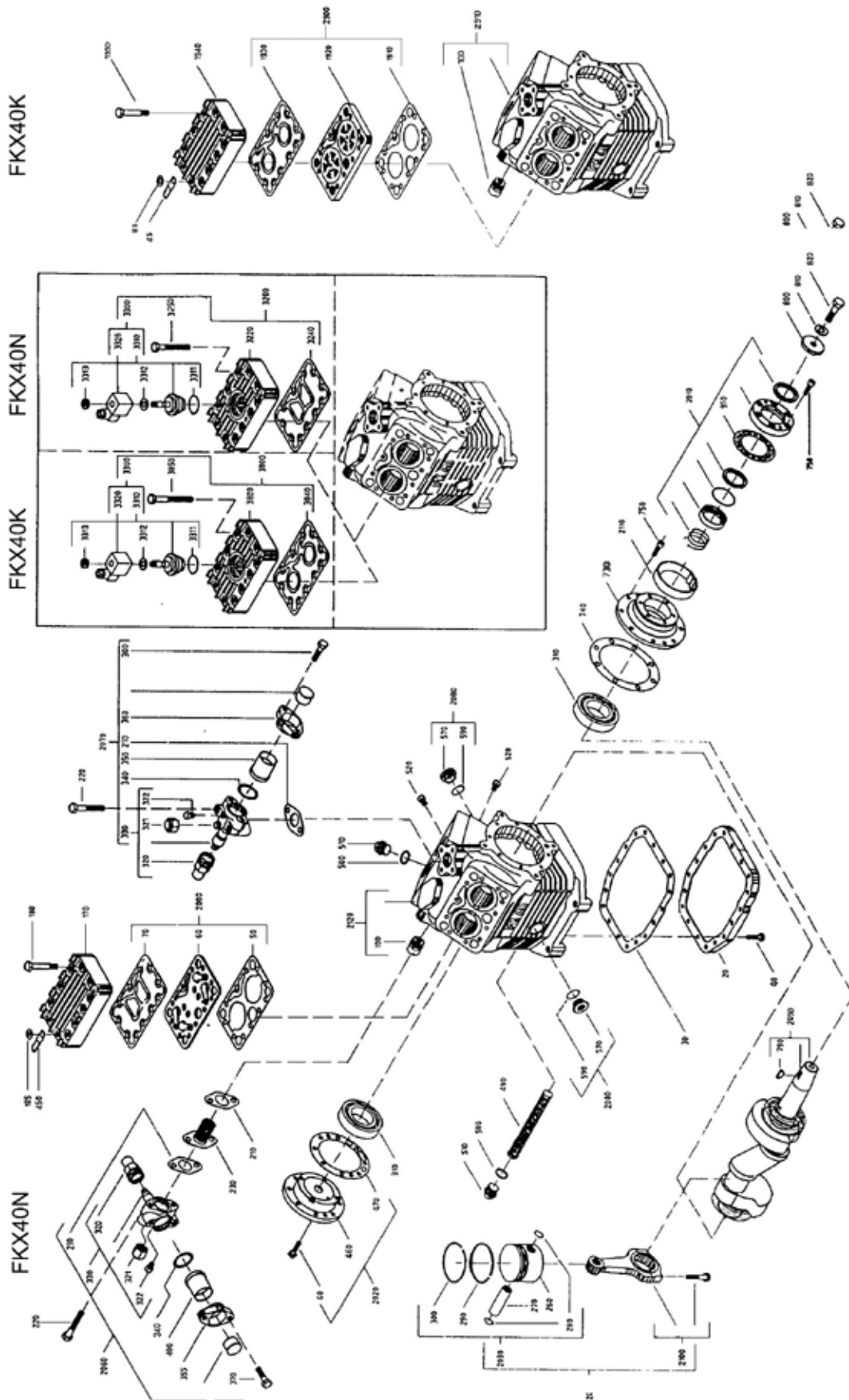

Posizione Position	470N	470K	560N	560K	655N	655K	Descrizione Description
	AM 5105	AM 5105	AM 5105	AM 5105	AM 5105	AM 5105	L 1 - Olio Fuchs Triton SE 55 - Fuchs Triton SE 55 oil
	AM 5098	AM 5098	AM 5098	AM 5098	AM 5098	AM 5098	L 5 - Olio Fuchs Triton SE 55 - Fuchs Triton SE 55 oil
	KO H99980230	KO H99980001	KO H99980230	KO H99980001	KO H99980230	KO H99980001	Kit guarnizioni - Gasket kit
30	KO H99906721	KO H99906721	KO H99906721	KO H99906721	KO H99906721	KO H99906721	Guarnizione coppa olio - Gasket-base plate
50/1910	KO H99905695	KO H99906161	KO H99905696	KO H99906641	KO H99905697	KO H99906642	Guarnizione inferiore piastra valvole - Gasket - Lower valve plate
170 (N) 1940 (K)	KO H99903384	KO H99903381	KO H99903384	KO H99903381	KO H99903384	KO H99903381	Coperchio testa - Cylinder cover
210	KO H99905083	KO H99905083	KO H99905083	KO H99905083	KO H99905083	KO H99905083	Guarnizione ovale - Oval gasket
230	KO H99903370	KO H99903370	KO H99903370	KO H99903370	KO H99903370	KO H99903370	Filtro aspirazione - Suction filter
290	KO H99905390	KO H99905390	KO H99906562	KO H99906562	KO H99906572	KO H99906572	Fascia elastica inferiore Ø 55 mm - Oil scraper ring piston
300	KO H99905380	KO H99905380	KO H99906563	KO H99906563	KO H99906564	KO H99906572	Fascia elastica superiore Ø 55 mm - Oil scraper ring piston
310	KO H99907755	KO H99907755	KO H99907755	KO H99907755	KO H99907755	KO H99907755	Cuscinetto anteriore o posteriore - Front or rear bearing
340	KO H99905067	KO H99905067	KO H99905067	KO H99905067	KO H99905067	KO H99905067	Guarnizione 42x34x1 - Gasket 42x34x1
490	KO H99906723	KO H99906723	KO H99906723	KO H99906723	KO H99906723	KO H99906723	Filtro carter - Oil filter
730	KO H99906726	KO H99906726	KO H99906726	KO H99906726	KO H99906726	KO H99906726	Flangia anteriore - Front flange
880	KO H99905063	KO H99905063	KO H99905063	KO H99905063	KO H99905063	KO H99905063	Guarnizioni premistoppa - Gasket-shaft seal cover
2000/2900	KO H99980240	KO H99980010	KO H99980241	KO H99980010	KO H99980241	KO H99980010	Kit piastra valvole - Valve plate kit
2010	AM 6400	AM 6400	AM 6400	AM 6400	AM 6400	AM 6400	Kit premistoppa - Shaft seal kit
2020	KO H99980017	KO H99980017	KO H99980017	KO H99980017	KO H99980017	KO H99980017	Kit pompa olio - Oil pump kit
2030	KO H99980103	KO H99980103	KO H99980104	KO H99980104	KO H99980105	KO H99980105	Kit pistone - Piston kit
2040	KO H99980109	KO H99980109	KO H99980110	KO H99980110	KO H99980111	KO H99980111	Kit pistone con biella - Set-piston-conn.w.2 rings/65
2080	KO H99908698	KO H99908698	KO H99908698	KO H99908698	KO H99908698	KO H99908698	Vetro spia Ø 18 con O-ring - Set-sight glass
	KO H99908552	KO H99908552	KO H99908552	KO H99908552	KO H99908552	KO H99908552	Vetro spia Ø 22 con O-ring - Set-sight glass
2100	KO H99981293	KO H99981293	KO H99981293	KO H99981293	KO H99981293	KO H99981293	Kit biella - Compressor connecting rod kit
2110	KO H99980129	KO H99980129	KO H99980129	KO H99980129	KO H99980129	KO H99980129	Feltro premistoppa - Set-clamp.ring w.felt insert
2120	KO H99981424	KO H99981424	KO H99981424	KO H99981424	KO H99981424	KO H99981424	Kit tubo scarico olio - Set-oil drain hose
3220 (N) 3820 (K)	KO H99903383	KO H99903323	KO H99903383	KO H99903323	KO H99903383	KO H99903323	Coperchio testata con foro parzializzatore - Cylinder cover
ACCESSORI ED ATTREZZATURA - ACCESSORIES AND TOOLS							
	KO H99981293	KO H99981293	KO H99981293	KO H99981293	KO H99981293	KO H99981293	Parzializzatore - Capacity regulator kit
	KO H99980022	KO H99980022	KO H99980022	KO H99980022	KO H99980022	KO H99980022	Kit adattatore rubinetti da FK4 a FKX40 Set-replacement adapter set the same shut-off valve
	AM 5476	AM 5476	AM 5476	AM 5476	AM 5476	AM 5476	Chiave regolazione rubinetti - Straight ratchet wrench
RUBINETTI - SHUT-OFF VALVES							
330	KO H99907128	KO H99907128	KO H99907128	KO H99907128	KO H99907128	KO H99907128	Rubinetto universale senza flangia - Valve without flange
2060	KO H99908084	KO H99908084	KO H99908084	KO H99908084	KO H99908084	KO H99908084	Rubinetto mandata con flangia AP - H.P. valve with flange
2070	KO H99908082	KO H99908082	KO H99908082	KO H99908082	KO H99908082	KO H99908082	Rubinetto aspirazione con flangia BP - L.P. valve with flange

RICAMBI COMPRESSORE BOCK FKX40

BOCK FKX40 Compressors spare parts







Pos. Pos.		470N	470K	560N	560K	655N	655K	Descrizione Description	OEM/Note OEM/Note
		AM 5105	AM 5105	AM 5105	AM 5105	AM 5105	AM 5105	L 1 Olio Fuchs Triton SE 55 Fuchs Triton SE 55 oil	
		AM 5098	AM 5098	AM 5098	AM 5098	AM 5098	AM 5098	L 5 Olio Fuchs Triton SE 55 Fuchs Triton SE 55 oil	
		KO H99980230		KO H99980230		KO H99980230		Kit guarnizioni Gasket kit	
			KO H99980001		KO H99980001		KO H99980001		
30		KO H99906721	KO H99906721	KO H99906721	KO H99906721	KO H99906721	KO H99906721	Guarnizione coppa olio Gasket-base plate	
50/1910		KO H99905695						Guarnizione inferiore piastra valvole Gasket - Lower valve plate	
			KO H99906161						
				KO H99905696					

RICAMBI COMPRESSORE BOCK FKX40

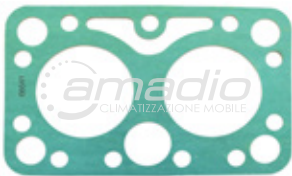
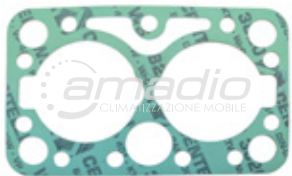
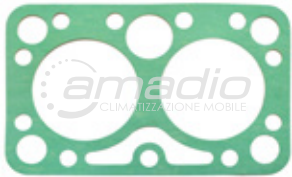
BOCK FKX40 Compressors spare parts









Pos. Pos.		470N	470K	560N	560K	655N	655K	Descrizione Description	OEM/Note OEM/Note
50/1910					KO H99906641			Guarnizione inferiore piastra valvole Gasket - Lower valve plate	
						KO H99905697			
							KO H99906642		
170 (N) 1940 (K)		KO H99903384	KO H99903381	KO H99903384	KO H99903381	KO H99903384	KO H99903381	Coperchio testa Cylinder cover	
210		KO H99905083	KO H99905083	KO H99905083	KO H99905083	KO H99905083	KO H99905083	Guarnizione ovale Oval gasket	
230		KO H99903370	KO H99903370	KO H99903370	KO H99903370	KO H99903370	KO H99903370	Filtro aspirazione Suction filter	
290		KO H99905390	KO H99905390					Fascia elastica inferiore Ø 55 mm Oil scraper ring piston	
300		KO H99905380	KO H99905380					Fascia elastica superiore Ø 55 mm Oil scraper ring piston	

RICAMBI COMPRESSORE BOCK FKX40

BOCK FKX40 Compressors spare parts









Pos. Pos.		470N	470K	560N	560K	655N	655K	Descrizione Description	OEM/Note OEM/Note
290				KO H99906562	KO H99906562			Fascia elastica inferiore Ø 60 mm Oil scraper ring piston	
300				KO H99906563	KO H99906563			Fascia elastica superiore Ø 60 mm Oil scraper ring piston	
290						KO H99906572	KO H99906572	Fascia elastica inferiore Ø 65 mm Oil scraper ring piston	
300						KO H99906564	KO H99906572	Fascia elastica superiore Ø 65 mm Oil scraper ring piston	
310		KO H99907755	KO H99907755	KO H99907755	KO H99907755	KO H99907755	KO H99907755	Cuscinetto anteriore o posteriore Front or rear bearing	
340		KO H99905067	KO H99905067	KO H99905067	KO H99905067	KO H99905067	KO H99905067	Guarnizione 42x34x1 Gasket 42x34x1	
490		KO H99906723	KO H99906723	KO H99906723	KO H99906723	KO H99906723	KO H99906723	Filtro carter Oil filter	
730		KO H99906726	KO H99906726	KO H99906726	KO H99906726	KO H99906726	KO H99906726	Flangia anteriore Front flange	

RICAMBI COMPRESSORE BOCK FKX40

BOCK FKX40 Compressors spare parts



Pos. Pos.		470N	470K	560N	560K	655N	655K	Descrizione Description	OEM/Note OEM/Note
880		KO H99905063	KO H99905063	KO H99905063	KO H99905063	KO H99905063	KO H99905063	Guarnizioni premistoppa Gasket-shaft seal cover	
2000/2900		KO H99980240	KO H99980010	KO H99980241	KO H99980010	KO H99980241	KO H99980010	Kit piastra valvole Valve plate kit	
2010		AM 6400	AM 6400	AM 6400	AM 6400	AM 6400	AM 6400	Kit premi-stoppa Shaft seal kit	
2020		KO H99980017	KO H99980017	KO H99980017	KO H99980017	KO H99980017	KO H99980017	Kit pompa olio Oil pump kit	
2030		KO H99980103	KO H99980103					Kit pistone Piston kit	
				KO H99980104	KO H99980104				
						KO H99980105	KO H99980105		

RICAMBI COMPRESSORE BOCK FKX40

BOCK FKX40 Compressors spare parts







Pos. Pos.		470N	470K	560N	560K	655N	655K	Descrizione Description	OEM/Note OEM/Note
2040		KO H99980109	KO H99980109	KO H99980110	KO H99980110	KO H99980111	KO H99980111	Kit pistone con biella Set-piston- conn.w.2 rings/65	
2080		KO H99908698	KO H99908698	KO H99908698	KO H99908698	KO H99908698	KO H99908698	Vetro spia Ø 18 con O-ring Set-sight glass	
2080		KO H99908552	KO H99908552	KO H99908552	KO H99908552	KO H99908552	KO H99908552	Vetro spia Ø 22 con O-ring Set-sight glass	
2100		KO H99981293	KO H99981293	KO H99981293	KO H99981293	KO H99981293	KO H99981293	Kit biella Compressor connecting rod kit	
2110		KO H99980129	KO H99980129	KO H99980129	KO H99980129	KO H99980129	KO H99980129	Feltro pre- mistoppa Set-clamp. ring w.felt insert	
2120		KO H99981424	KO H99981424	KO H99981424	KO H99981424	KO H99981424	KO H99981424	Kit tubo scarico olio Set-oil drain hose	
3220 (N) 3820 (K)		KO H99903383	KO H99903323	KO H99903383	KO H99903323	KO H99903383	KO H99903323	Coperchio testata con foro par- zializzatore Cylinder cover	
					SPH SPH4073			Tubazione DN20 Angle line DN20	

RICAMBI COMPRESSORE BOCK FKX40

BOCK FKX40 Compressors spare parts



Pos. Pos.		470N	470K	560N	560K	655N	655K	Descrizione Description	OEM/Note OEM/Note
ACCESSORI ED ATTREZZATURA - ACCESSORIES AND TOOLS									
		KO H99908418	KO H99908418	KO H99908418	KO H99908418	KO H99908418	KO H99908603	Kit parzializzatore Capacity regulator kit	
		KO H99980022	KO H99980022	KO H99980022	KO H99980022	KO H99980022	KO H99980022	Kit adattatore rubinetti da FK4 a FKX40 Set-replacement adapter set the same shut-off valve	
		AM 5476	AM 5476	AM 5476	AM 5476	AM 5476	AM 5476	Chiave regolazione rubinetti Straight ratchet wrenche	
RUBINETTI - SHUT-OFF VALVES									
330		KO H99907128	KO H99907128	KO H99907128	KO H99907128	KO H99907128	KO H99907128	Rubinetto universale senza flangia Shut-off valve without flange	
2060		KO H99908084	KO H99908084	KO H99908084	KO H99908084	KO H99908084	KO H99908084	Rubinetto mandata con flangia AP H.P. Shut-off valve with flange	
2070		KO H99908082	KO H99908082	KO H99908082	KO H99908082	KO H99908082	KO H99908082	Rubinetto aspirazione con flangia BP L.P. Shut-off valve with flange	

COMPRESSORI GEA BOCK FKX50

Gea Bock FKX50 Compressors



FKX50 - FKX50



Dati Tecnici / Technical Data

Cilindrata Displacement	Varianti: 460/555/660/775/830/980
Numero Cilindri No. of Cylinders	6
Refrigerante Refrigerant	R134a/R404A/R407CF/R507/R22
Tipo Olio Oil Type	Reniso Triton SE 55 (o Equiv.) N.B. per gas R22 Reniso SP 46 (o Equiv.)
Quantità Olio Oil Quantity	2500 cc
Giri MAX Maximun Speed	3000 r.p.m. (serie "N") 3500 r.p.m. (serie "K")
Inclinazione MAX Maximun Inclination	15°
Raccordo Aspirazione Suction Fitting	28 mm - 1 1/8 "
Raccordo Mandata Discharge Fitting	35 mm - 1 3/8 "

N.B. Raccordi mandata e ritorno da cilindrata 660 fino a 980 con filetto 35 mm - 1 3/8"





COMPRESSORI GEA BOCK FKX50

Gea Bock FKX50 Compressors



FKX50 - FKX50

SENZA FLANGE / Without flanges						
	Codice Code	Descrizione Description	Cilindrata Displacement	Quantità Olio Oil quantity	Codice Olio Oil code	OEM/Note OEM/Note
	AM 7412SF	FKX50/660K	662 cc	FUCHS SE 55 - LT. 2,6	AM 5105 (L 1) AM 5098 (L 5)	
	AM 7411SF	FKX50/775K	775 cc	FUCHS SE 55 - LT. 2,6	AM 5105 (L 1) AM 5098 (L 5)	
	AM 7714SF	FKX50/830K	831 cc	FUCHS SE 55 - LT. 2,6	AM 5105 (L 1) AM 5098 (L 5)	
	AM 7716SF	FKX50/980K	976 cc	FUCHS SE 55 - LT. 2,6	AM 5105 (L 1) AM 5098 (L 5)	

SENZA RUBINETTI / Without valves						
	Codice Code	Descrizione Description	Cilindrata Displacement	Quantità Olio Oil quantity	Codice Olio Oil code	OEM/Note OEM/Note
	AM 7714SR	FKX50/830K	831 cc	FUCHS SE 55 - LT. 2,6	AM 5105 (L 1) AM 5098 (L 5)	
	AM 7716SR	FKX50/980K	976 cc	FUCHS SE 55 - LT. 2,6	AM 5105 (L 1) AM 5098 (L 5)	

RICAMBI COMPRESSORE BOCK FKX50

BOCK FKX50 Compressors spare parts

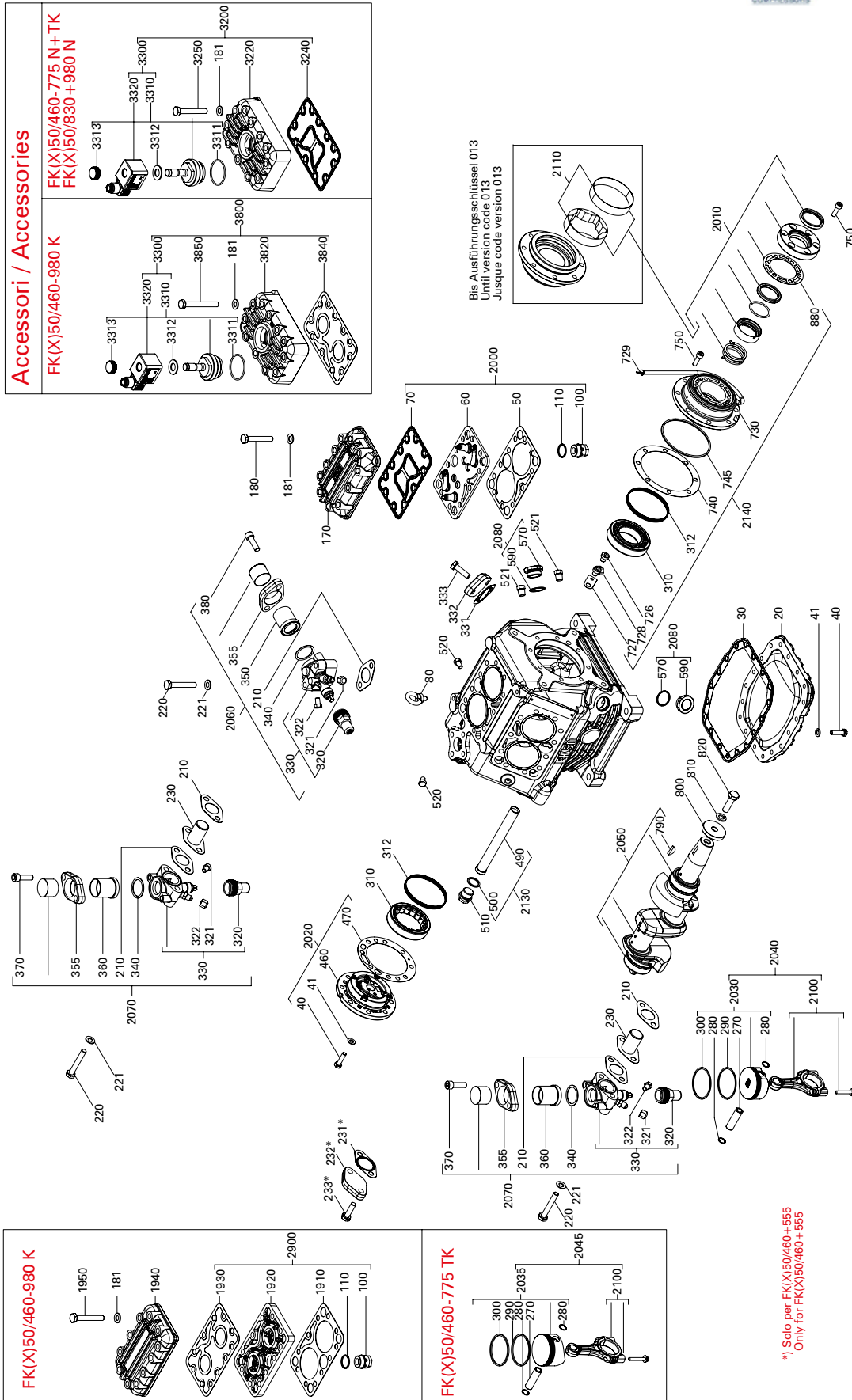

RICAMBI COMPRESSORE BOCK FKX50

BOCK FKX50 Compressors spare parts













Posizione Position	FKX50/660K	FKX50/775K	FKX50/830K	FKX50/980K	Descrizione Description
	AM 5105	AM 5105	AM 5105	AM 5105	L 1 - Olio Fuchs Triton SE 55 - Fuchs Triton SE 55 oil
	AM 5098	AM 5098	AM 5105	AM 5105	L 5 - Olio Fuchs Triton SE 55 - Fuchs Triton SE 55 oil
210	KO H99905083	KO H99905083	KO H99905083	KO H99905083	Guarnizione ovale Oval gasket
230	KO H99903370	KO H99903370	KO H99903370	KO H99903370	Filtro aspirazione Suction filter
290	KO H99906562	KO H99906572	KO H99905056	KO H99905057	Fascia elastica inferiore Oil scraper ring piston
300	KO H99906564	KO H99906564	KO H99905058	KO H99905059	Fascia elastica superiore Oil scraper ring piston
310	KO H99907755	KO H99907755	KO H99907755	KO H99907755	Kit cuscinetto posteriore o anteriore Front or rear bearing
340	KO H99905067	KO H99905067	KO H99905067	KO H99905067	Guarnizione 42x34x1 Gasket 42x34x1
1910	KO H99906641	KO H99906642	KO H99906641	KO H99906642	Guarnizione inferiore piastra valvole Gasket - Lower valve plate
2010	AM 6400	AM 6400	AM 6400	AM 6400	Kit premistoppa Shaft seal kit
2020	KO H99980017	KO H99980017	KO H99980017	KO H99980017	Kit pompa olio Oil pump kit
2030	KO H99980104	KO H99980105	KO H99980616	KO H99980617	Kit pistone Piston kit
2090	KO H99980089	KO H99980089	KO H99980089	KO H99980089	Kit guarnizioni completa serie K Gasket kit
2100	KO H99980090	KO H99980090	KO H99980090	KO H99980090	Kit biella Compressor connecting rod kit
2900	KO H99908926	KO H99908926	KO H99908926	KO H99908926	Kit piastra valvole Valve plate kit
ACCESSORI ED ATTREZZATURA - ACCESSORIES AND TOOLS					
3300	KO H99908418	KO H99908418	KO H99908418	KO H99908418	Parzializzatore - Capacity regulator kit
	KO H99980022	KO H99980022	KO H99980022	KO H99980022	Kit adattatore rubinetti da FK4 a FKX40 Set-replacement adapter set the same shut-off valve
	AM 5476	AM 5476	AM 5476	AM 5476	Chiave regolazione rubinetti - Straight ratchet wrench
RUBINETTI - SHUT-OFF VALVES					
2060	KO H99980101	KO H99980101	KO H99980101	KO H99980101	Rubinetto aspir. con flangia NW32 Set shut-off valve NW32
2070					
330	KO H99907130	KO H99907130	KO H99907130	KO H99907130	Solo corpo mandata con flangia NW25 Shut-off valve NW25

RICAMBI COMPRESSORE BOCK FKX50

BOCK FKX50 Compressors spare parts



Posizione Position		FKX50/660K	FKX50/775K	FKX50/830K	FKX50/980K	Descrizione Description	OEM/Note OEM/Note
		AM 5105	AM 5105	AM 5105	AM 5105	L 1 Olio Fuchs Triton SE 55 Fuchs Triton SE 55 oil	
		AM 5098	AM 5098	AM 5098	AM 5098	L 5 Olio Fuchs Triton SE 55 Fuchs Triton SE 55 oil	
210		KO H99905083	KO H99905083	KO H99905083	KO H99905083	Guarnizione ovale Oval gasket	
230		KO H99903370	KO H99903370	KO H99903370	KO H99903370	Filtro aspirazione Suction filter	
290		KO H99906562	KO H99906572	KO H99950506	KO H99950507	Fascia elastica inferiore Ø 65 Oil scraper ring piston	
300		KO H99906563	KO H99906564	KO H99950508	KO H99950509	Fascia elastica superiore Ø 65 Oil scraper ring piston	
310		KO H99907755	KO H99907755	KO H99907755	KO H99907755	Kit cuscinetto posteriore o anteriore Front or rear bearing	
340		KO H99905067	KO H99905067	KO H99905067	KO H99905067	Guarnizione 42x34x1 Gasket 42x34x1	
1910		KO H99906641	KO H99906642	KO H99906641	KO H99906642	Guarnizione inferiore piastra valvole Gasket - Lower valve plate	
2010		AM 6400	AM 6400	AM 6400	AM 6400	Kit premistoppa Shaft seal kit	
2020		KO H99980017	KO H99980017	KO H99980017	KO H99980017	Kit pompa olio Oil pump kit	

RICAMBI COMPRESSORE BOCK FKX50

BOCK FKX50 Compressors spare parts



Posizione Position		FKX50/660K	FKX50/775K	FKX50/830K	FKX50/980K	Descrizione Description	OEM/Note OEM/Note
2030				KO H99980616	KO H99980617	Kit pistone Piston kit	8862140006900 80103 240175096
2030		KO H99980104					80104
2090		KO H99980089	KO H99980089	KO H99980089	KO H99980089	Kit guarnizioni completa serie K Gasket kit	8862140005900 08893 - 80105 H99908893 240174722
2100		KO H99980090	KO H99980090	KO H99980090	KO H99980090	Kit biella Compressor con- necting rod kit	
2900		KO H99908926	KO H99908926	KO H99908926	KO H99908926	Kit piastra valvole Valve plate kit	
ACCESSORI ED ATTREZZATURA - ACCESSORIES AND TOOLS							
3300		KO H99908418	KO H99908418	KO H99908418	KO H99908418	Parzializzato- re - Capacity regulator kit	88-62-14- 00192 08418 - 503137535 240174690
		KO H99980022	KO H99980022	KO H99980022	KO H99980022	Kit adattatore rubinetti da FK4 a FKX40 Set-replacement adapter set for the same shut-off valve	
		AM 5476	AM 5476	AM 5476	AM 5476	Chiave regola- zione rubinetti - Straight ratchet wrenche	
RUBINETTI - SHUT-OFF VALVES							
2060 2070		KO H99980101	KO H99980101	KO H99980101	KO H99980101	Rubinetti aspir. con flangia NW32 Set shut-off valve NW32	80101
330		KO H99907130	KO H99980101	KO H99980101	KO H99980101	Solo corpo man- data con flangia NW25 Shut-off valve NW25	

RICAMBI COMPRESSORE BOCK FKX26
BOCK FKX26 Compressors spare parts

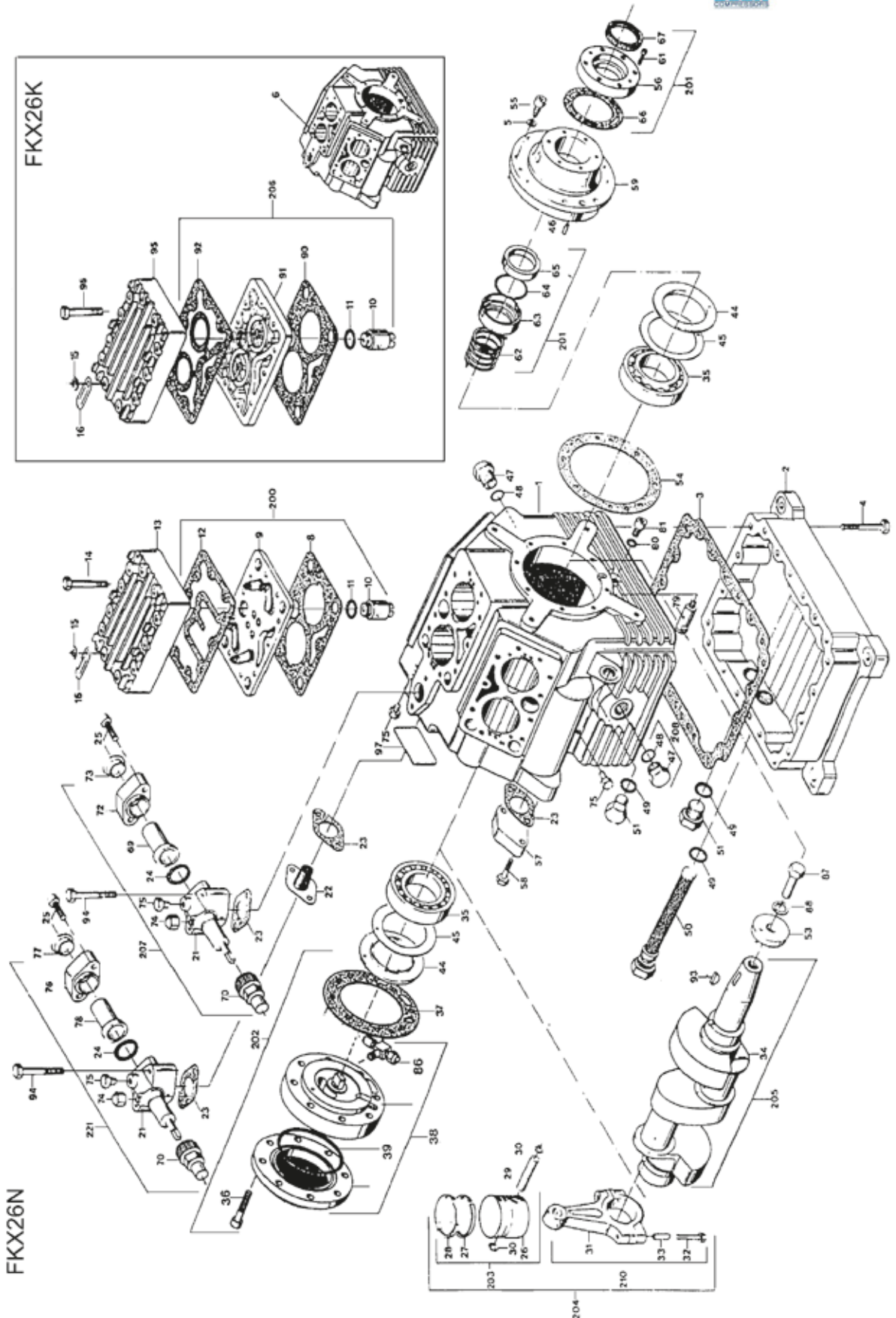













Posizione Position	470N	470K	550N	550K	670N	670K	Descrizione Description
	AM 5105	AM 5105	AM 5105	AM 5105	AM 5105	AM 5105	L 1 - Olio Fuchs Triton SE 55 - Fuchs Triton SE 55 oil
	AM 5098	AM 5098	AM 5098	AM 5098	AM 5098	AM 5098	L 5 - Olio Fuchs Triton SE 55 - Fuchs Triton SE 55 oil
	KO H99908700	KO H99908700	KO H99908700	KO H99908700	KO H99908700	KO H99908720	Kit guarnizioni Gasket kit
	KO H99906184	KO H99908720		KO H99906184			
8/9		KO H99906161	KO H99905674			KO H99906161	Guarnizione inferiore piastra valvole Gasket - Lower valve plate
				KO H99906178			
12/92	KO H99906730		KO H99906730		KO H99906730		Guarnizione superiore piastra valvole Gasket - Upper valve plate
		KO H99906162		KO H99906162		KO H99906162	
22	KO H99903370	KO H99903370	KO H99903370	KO H99903370	KO H99903370	KO H99903370	Filtro aspirazione - Suction filter
23	KO H99905083	KO H99905083	KO H99905083	KO H99905083	KO H99905083	KO H99905083	Guarnizione ovale - Oval gasket
24	KO H99905067	KO H99905067	KO H99905067	KO H99905067	KO H99905067	KO H99905067	Guarnizione 42x34x1 - Gasket 42x34x1
35	KO H99907742	KO H99907742	KO H99907742	KO H99907742	KO H99907742	KO H99907742	Cuscinetto posteriore o anteriore Front or rear bearing
50	KO H99904442	KO H99904442	KO H99904442	KO H99904442	KO H99904442	KO H99904442	Filtro carter - Oil filter
200/206		KO H99908690	KO H99908690		KO H99908690		Kit piastra valvole - Valve plate kit
				KO H99908926		KO H99908926	
201	AM 6402	AM 6402	AM 6402	AM 6402	AM 6402	AM 6402	Kit premistoppa - Shaft seal kit
202	KO H99908384	KO H99908384	KO H99908384	KO H99908384	KO H99908384	KO H99908384	Kit pompa olio - Oil pump kit
203	KO H99980103	KO H99980103			KO H99980103	KO H99980103	Kit pistone - Piston kit
			KO H99980102				
210	KO H99908638	KO H99908638					Kit biella - Compressor connecting rod kit
			KO H99908637		KO H99908637	KO H99908637	
ACCESSORI ED ATTREZZATURA - ACCESSORIES AND TOOLS							
	KO H99908418	KO H99908418	KO H99908418	KO H99908418	KO H99908418	KO H99908603	Parzializzatore - Capacity regulator kit
	KO H99980022	KO H99980022	KO H99980022	KO H99980022	KO H99980022	KO H99980022	Kit adattatore rubinetti da FK4 a FKX40 Set-replacement adapter set the same shut-off valve
	AM 5476	AM 5476	AM 5476	AM 5476	AM 5476	AM 5476	Chiave regolazione rubinetti - Straight ratchet wrench
RUBINETTI - SHUT-OFF VALVES							
21	KO H99907128	KO H99907128	KO H99907128	KO H99907128	KO H99907128	KO H99907128	Rubinetto universale senza flangia - Valve without flange
207	KO H99908084	KO H99908084	KO H99908084	KO H99908084	KO H99908084	KO H99908084	Rubinetto mandata con flangia AP - H.P. valve with flange
221	KO H99908082	KO H99908082	KO H99908082	KO H99908082	KO H99908082	KO H99908082	Rubinetto aspirazione con flangia BP - L.P. valve with flange

RICAMBI COMPRESSORE BOCK FKX26

BOCK FKX26 Compressors spare parts







Posizione Position		470N	470K	550N	550K	670N	670K	Descrizione Description
	 	AM 5105	AM 5105	AM 5105	AM 5105	AM 5105	AM 5105	L 1 Olio Fuchs Triton SE 55 Fuchs Triton SE 55 oil
	 	AM 5098	AM 5098	AM 5098	AM 5098	AM 5098	AM 5098	L 5 Olio Fuchs Triton SE 55 Fuchs Triton SE 55 oil
		KO H99908700		KO H99908700		KO H99908700		Serie guarnizioni compl. Gasket kit
			KO H99908720		KO H99908720		KO H99908720	
8/9	 	KO H99906184				KO H99906184		Guarnizione inferiore piastra valvole Gasket - Lower valve plate
	 		KO H99906161				KO H99906161	
				KO H99905674				
						KO H99906178		

RICAMBI COMPRESSORE BOCK FKX26

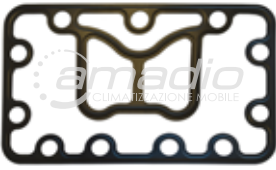
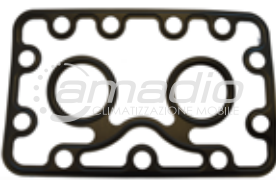
BOCK FKX26 Compressors spare parts









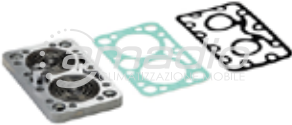

Posizione Position		470N	470K	550N	550K	670N	670K	Descrizione Description
12/92		KO H99906730		KO H99906730		KO H99906730		Guarnizione superiore piastra valvole Gasket - Upper valve plate
			KO H99906162		KO H99906162		KO H99906162	
22		KO H99903370	KO H99903370	KO H99903370	KO H99903370	KO H99903370	KO H99903370	Filtro aspirazione Suction filter
23		KO H99905083	KO H99905083	KO H99905083	KO H99905083	KO H99905083	KO H99905083	Guarnizione ovale Oval gasket
24		KO H99905067	KO H99905067	KO H99905067	KO H99905067	KO H99905067	KO H99905067	Guarnizione 42x34x1 Gasket 42x34x1
35		KO H99907742	KO H99907742	KO H99907742	KO H99907742	KO H99907742	KO H99907742	Cuscinetto poste- riore o anteriore Front or rear bearing

RICAMBI COMPRESSORE BOCK FKX26

BOCK FKX26 Compressors spare parts









Posizione Position		470N	470K	550N	550K	670N	670K	Descrizione Description
50		KO H99904442	KO H99904442	KO H99904442	KO H99904442	KO H99904442	KO H99904442	Filtro carter Oil filter
200/206		KO H99908690		KO H99908690		KO H99908690		Kit piastra valvole Valve plate kit
			KO H99908926		KO H99908926		KO H99908926	
201		AM 6402	AM 6402	AM 6402	AM 6402	AM 6402	AM 6402	Kit premistoppa Shaft seal kit
202		KO H99908384	KO H99908384	KO H99908384	KO H99908384	KO H99908384	KO H99908384	Kit pompa olio Oil pump kit
203		KO H99980103	KO H99980103			KO H99980103	KO H99980103	Kit pistone Piston kit
				KO H99980102	KO H99980102			
		KO H99908638	KO H99908638	KO H99908637	KO H99908637	KO H99908637	KO H99908637	Kit biella Compressor con- necting rod kit

RICAMBI COMPRESSORE BOCK FKX26

BOCK FKX26 Compressors spare parts



Posizione Position		470N	470K	550N	550K	670N	670K	Descrizione Description
ACCESSORI ED ATTREZZATURA - ACCESSORIES AND TOOLS								
		KO H99908418	KO H99908418	KO H99908418	KO H99908418	KO H99908418	KO H99908418	Parzializzatore - Capacity regulator kit
		KO H99980022	KO H99980022	KO H99980022	KO H99980022	KO H99980022	KO H99980022	Kit adattatore rubinetti da FK4 a FKX40 Set-replacement adapter set the same shut-off valve
		AM 5476	AM 5476	AM 5476	AM 5476	AM 5476	AM 5476	Chiave regola- zione rubinetti Straight ratchet wrenche
RUBINETTI - SHUT-OFF VALVES								
21		KO H99907128	KO H99907128	KO H99907128	KO H99907128	KO H99907128	KO H99907128	Rubinetto univer- sale senza flangia Valve without flange
207		KO H99908084	KO H99908084	KO H99908084	KO H99908084	KO H99908084	KO H99908084	Rubinetto manda- ta con flangia AP - H.P. valve with flange
221		KO H99908082	KO H99908082	KO H99908082	KO H99908082	KO H99908082	KO H99908082	Rubinetto aspira- zione con flangia BP - L.P. valve with flange

RICAMBI COMPRESSORE BOCK FK5
BOCK FK5 Compressors spare parts

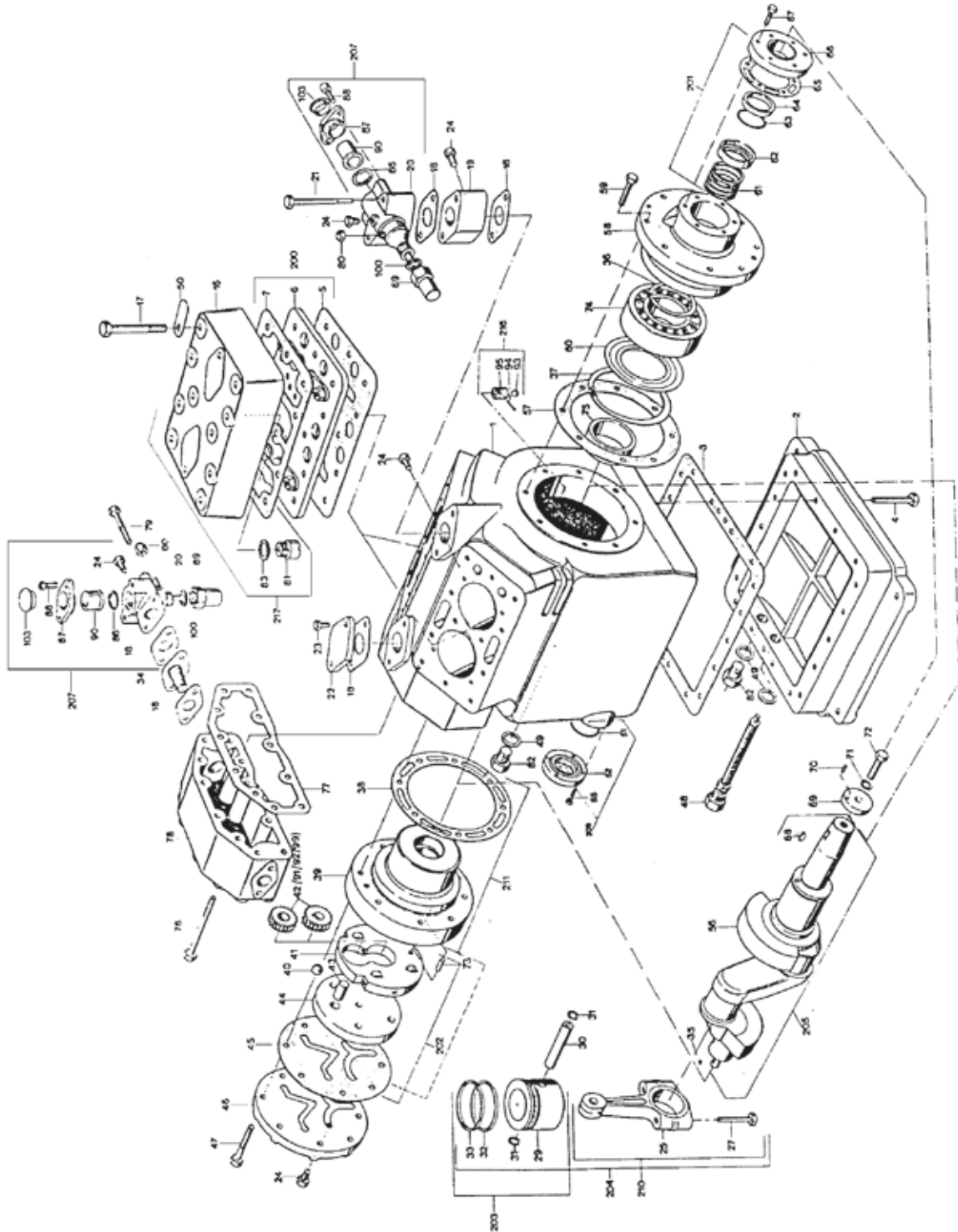

RICAMBI COMPRESSORE BOCK FK5

BOCK FK5 Compressors spare parts

















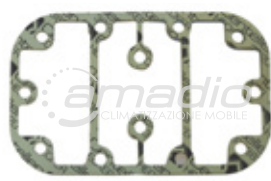
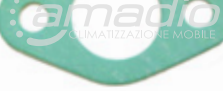

Posizione Position	FK5	Descrizione Description
	AM 5105	L 1 Olio Fuchs Triton SE 55 - Fuchs Triton SE 55 oil
	AM 5098	L 5 Olio Fuchs Triton SE 55 - Fuchs Triton SE 55 oil
5	KO H99905030	Guarnizione inferiore piastra valvole Gasket - Lower valve plate
7	KO H99905012	Guarnizione superiore piastra valvole Gasket - Upper valve plate
18	KO H99905083	Guarnizione ovale Oval gasket
31	KO H99905569	Anello seeger 20x1 Seeger ring 20x1
33	KO H99905381	Fascia elastica Oil scraper ring piston
34	KO H99903370	Filtro aspirazione Suction filter
48	KO H99904442	Filtro olio Oil filter
60	KO H99907327	Anello tenuta cuscinetto Bearing bush
74	KO H99907326	Cuscinetto anteriore Front bearing
77	KO H99905072	Guarnizione Gasket
81	KO H99907940	Valvola Valve
86	KO H99905067	Guarnizione 42x34x1 Gasket 42x34x1
100	KO H99905808	Rondella alluminio 20x16x1,5 Aluminum washer 20x16x1,5
200 (comprende 5/6/7/8/9/10/11/12/13/73)	KO H99908436	Kit piastra valvole Valve plate kit
201 (comprende 61/62/63/64/65/66)	AM 6401	Kit premistoppa Shaft seal kit
202 (comprende 40/41/42/43/44/45/73)	KO H99908044	Kit pompa olio Oil pump kit
203 (comprende 29/30/31/32/33)	KO H99908035	Kit pistone Piston kit
210 (comprende 25/26/27)	KO H99908307	Kit biella Compressor connecting rod kit
.... (comprende 3/5/7/9/18/38/45/49/51/57/ 65/77/83/86)	KO H99908072	Kit guarnizioni completa Gasket kit
	KO H99908491	Valvola by pass - By-pass valve
ACCESSORI ED ATTREZZATURA - ACCESSORIES AND TOOLS		
	KO H99908418	Parzializzatore - Capacity regulator kit
	AM 5476	Chiave regolazione rubinetti Straight ratchet wrenche
RUBINETTI - SHUT-OFF VALVES		
	KO H99907128	Rubinetto universale senza flangia - Valve without flange
	KO H99908082	Rubinetto aspirazione con flangia BP - L.P. valve with flange

RICAMBI COMPRESSORE BOCK FK5

BOCK FK5 Compressors spare parts











Posizione Position		Codice Code	Descrizione Description	OEM/Note OEM/Note
	 	AM 5105	L 1 Olio Fuchs Triton SE 55 Fuchs Triton SE 55 oil	
	 	AM 5098	L 5 Olio Fuchs Triton SE 55 Fuchs Triton SE 55 oil	
5	 	KO H99905030	Guarnizione inferiore piastra valvole Gasket - Lower valve plate	
7	 	KO H99905012	Guarnizione superiore piastra valvole Gasket - Upper valve plate	
18	 	KO H99905083	Guarnizione ovale Oval gasket	
31	 	KO H99905569	Anello seeger 20x1 Seeger ring 20x1	
33	 	KO H99905381	Fascia elastica Oil scraper ring piston	
34	 	KO H99903370	Filtro aspirazione Suction filter	
48	 	KO H99904442	Filtro olio Oil filter	

RICAMBI COMPRESSORE BOCK FK5

BOCK FK5 Compressors spare parts



Posizione Position		Codice Code	Descrizione Description	OEM/Note OEM/Note
60		KO H99907327	Anello tenuta cuscinetto Bearing bush	
74		KO H99907326	Cuscinetto anteriore Front bearing	
77		KO H99905072	Guarnizione Gasket	
81		KO H99907940	Valvola Valve	
86		KO H99905067	Guarnizione 42x34x1 Gasket 42x34x1	
100		KO H99905808	Rondella alluminio 20x16x1,5 Aluminum washer 20x16x1,5	
200 (comprende 5/6/7/8/9/10/11/12/13/73)		KO H99908436	Kit piastra valvole Valve plate kit	
201 (comprende 61/62/63/64/65/66)		AM 6401	Kit premistoppa Shaft seal kit	

RICAMBI COMPRESSORE BOCK FK5

BOCK FK5 Compressors spare parts



Posizione Position		Codice Code	Descrizione Description	OEM/Note OEM/Note
202 (comprende 40/41/42/43/ 44/45/73)		KO H99908044	Kit pompa olio Oil pump kit	
203 (comprende 29/30/31/32/33)		KO H99908035	Kit pistone Piston kit	
210 (comprende 25/26/27)		KO H99908307	Kit biella Compressor connecting rod kit	
..... (comprende 3/5 /7/9/18/38/45/49/51/ 57/65/77/83/86)		KO H99908072	Kit guarnizioni completa Gasket kit	
		KO H99908491	Valvola by pass By-pass valve	

RICAMBI COMPRESSORE BOCK FK5

BOCK FK5 Compressors spare parts



Posizione Position		Codice Code	Descrizione Description	OEM/Note OEM/Note
ACCESSORI ED ATTREZZATURA - ACCESSORIES AND TOOLS				
		KO H99908418	Parzializzatore - Capacity regulator kit	
		AM 5476	Chiave regolazione rubinetti Straight ratchet wrench	
RUBINETTI - SHUT-OFF VALVES				
20		KO H99907128	Rubinetto universale senza flangia - Valve without flange	
207		KO H99908082	Rubinetto aspirazione con flangia BP - L.P. valve with flange	

COMPRESSORI BITZER

Bitzer Compressors



4UFCY Tabella informativa ingombri e dimensioni - Dimensions and Connections

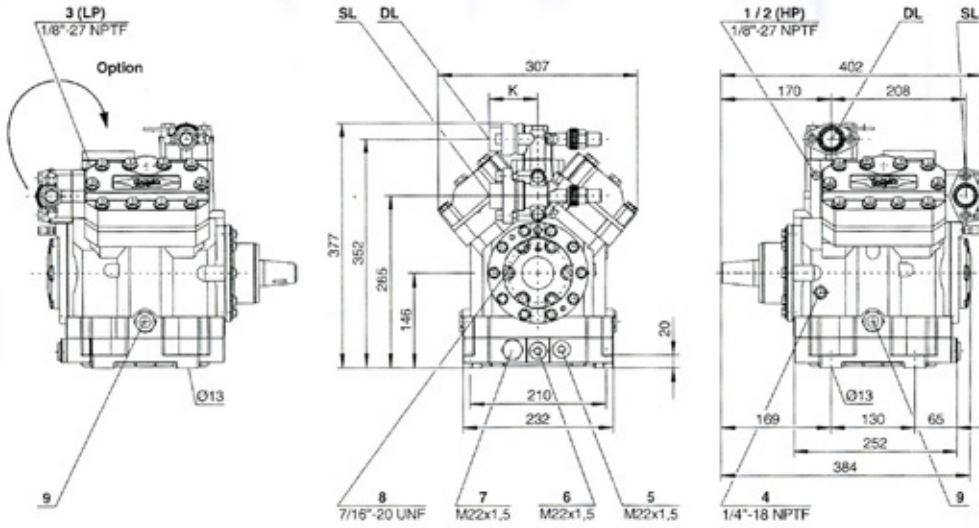

6UFCY Tabella informativa ingombri e dimensioni - Dimensions and Connections

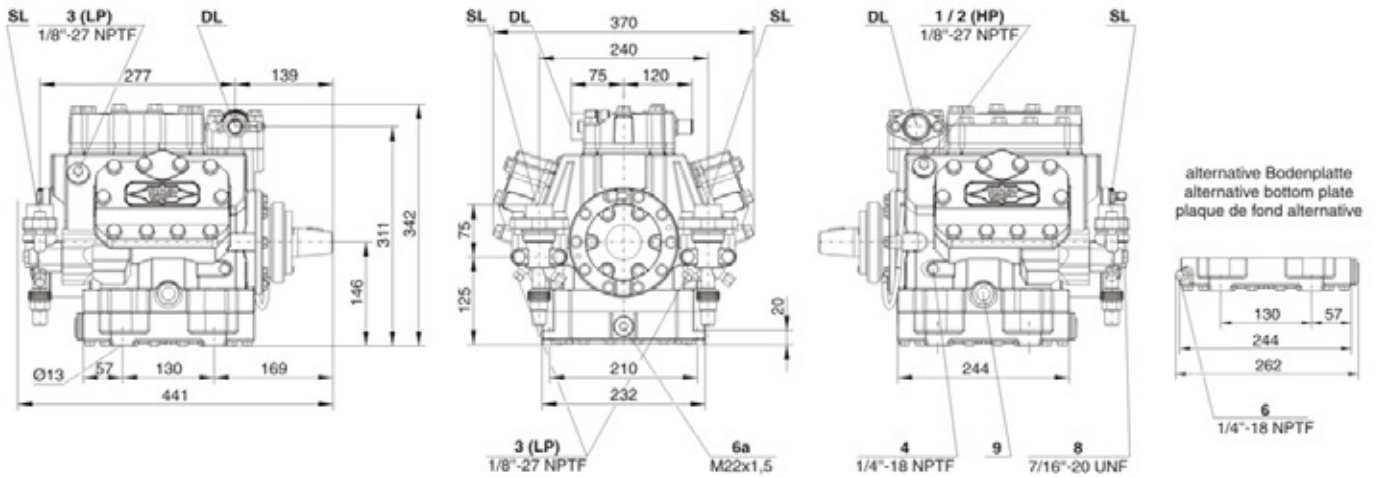

COMPRESSORI BITZER (4 CILINDRI)

Bitzer Compressors (4 cylindres)



Dati Tecnici / Technical Data	
Cilindrata Displacement	Varianti: 400/475/558/647
Numero Cilindri No. of Cylinders	4
Refrigerante Refrigerant	R134a
Tipo Olio Oil Type	SE 55 AM 5105 (L 1) AM 5098 (L 5)
Quantità Olio Oil Quantity	1,5 L
Giri MAX Maximun Speed	500 ÷ 3500 1/min

SERIE 4

COMPLETO

Codice Code	Descrizione Description	Cilindrata Displacement	Quantità Olio Oil quantity	Codice Olio Oil code	OEM/Note OEM/Note
AM 7435	Compressore Bitzer 4UFCY	400 cc	FUCHS SE 55 - LT. 1,5	AM 5105 (L 1) AM 5098 (L 5)	
AM 7460	Compressore Bitzer 4TFCY (Konvekta KV4)	475 cc	FUCHS SE 55 - LT. 1,5	AM 5105 (L 1) AM 5098 (L 5)	88779706040 A0038303560 A6328350003 69047A-B
AM 7461	Compressore Bitzer 4PFCY (Konvekta KV5)	558 cc	FUCHS SE 55 - LT. 1,5	AM 5105 (L 1) AM 5098 (L 5)	83779706510 83779706515 A0038303660 A6328350103 1100241A-B
AM 7462	Compressore Bitzer 4NFCY (Konvekta KV6)	647 cc	FUCHS SE 55 - LT. 1,5	AM 5105 (L 1) AM 5098 (L 5)	A6328350203 - 1100004A-B

MOTORI E6/ E6 engines

	Codice Code	Descrizione Description	Cilindrata Displacement	Quantità Olio Oil quantity	Codice Olio Oil code	OEM/Note OEM/Note
	AM 7460E6	4TFCY	475 cc	FUCHS SE 55 - LT. 1,5	AM 5105 (L 1) AM 5098 (L 5)	Nuova versione per motori Mercedes Euro6 New version for Mercedes Euro6 engines
	AM 7461E6	4PFCY	558 cc			
	AM 7462E6	4NFCY	647 cc			

RICAMBI COMPRESSORI BITZER (4 CILINDRI)
Bitzer Compressors spare parts (4 cylinders)

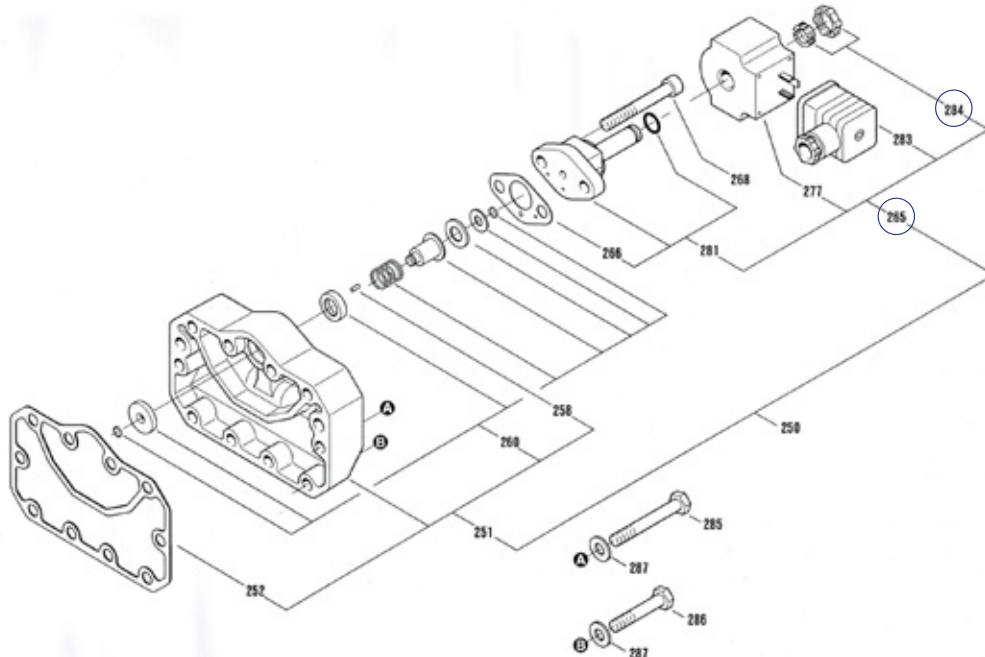

4UFC .. 4NFC
4UFR .. 4NFR

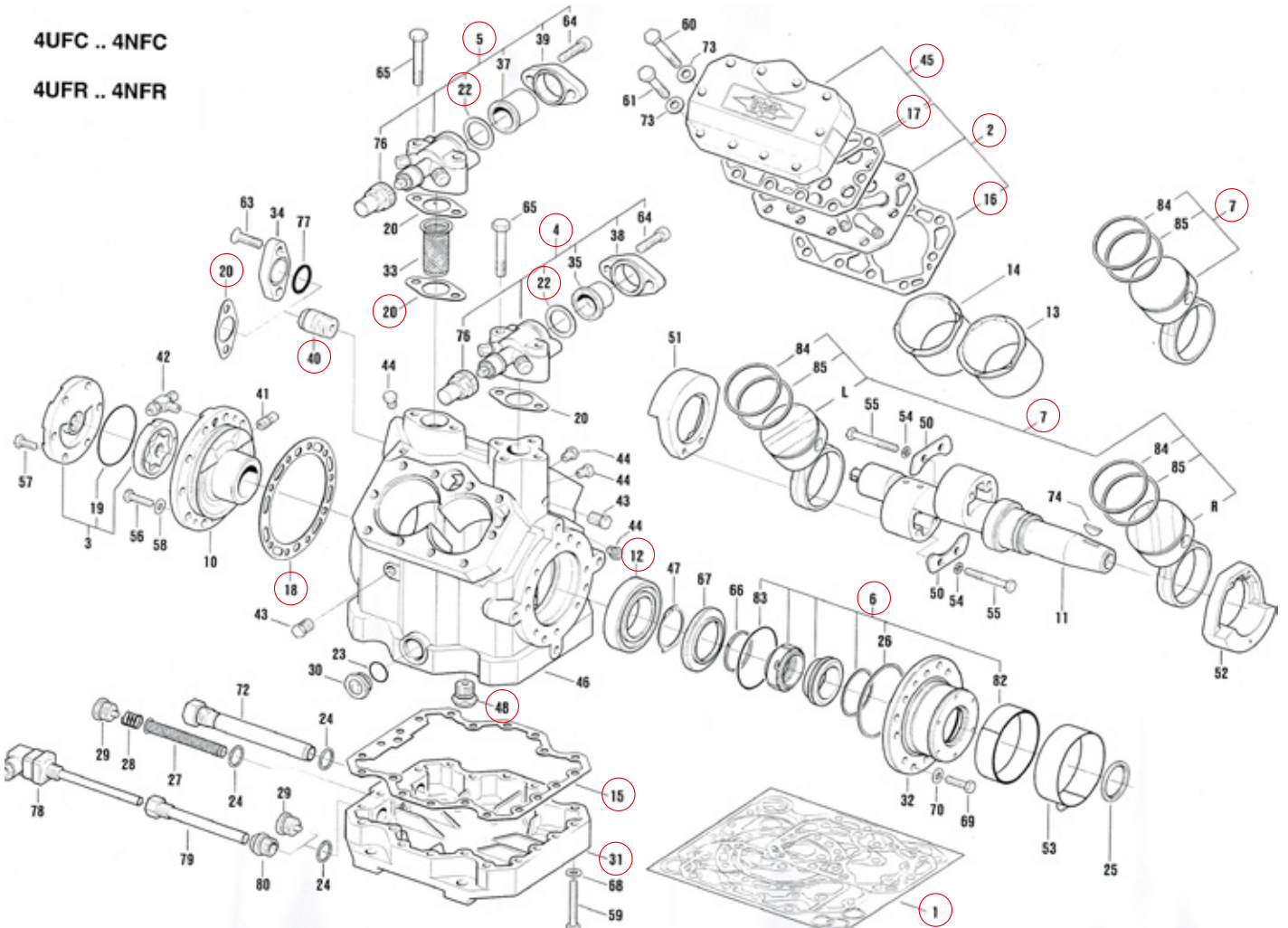

RICAMBI COMPRESSORI BITZER (4 CILINDRI)

Bitzer Compressors spare parts (4 cylinders)



Posizione Position	AM 7435 4UFCY	AM 7460 4TFCY	AM 7461 4PFCY	AM 7462 4NFCY	Descrizione Description
1	AM 5937	AM 5952	AM 5923	AM 5935	Kit guarnizioni completo Gasket kit
2	AM 5966	AM 5932	AM 5933	AM 5956	Kit piastra valvole Valve plate kit
6	AM 5921	AM 5921	AM 5921	AM 5921	Kit premistoppa Shaft seal kit
7		AM 5947	AM 5934	AM 5945	Kit pistone Piston kit
12	AM 5922	AM 5922	AM 5922	AM 5922	Cuscinetto anteriore Front bearing
15	AM 5930	AM 5930	AM 5930	AM 5930	Guarnizione basamento Gasket
16		AM 5954	AM 5948	AM 5957	Guarnizione inferiore piastra valvole Gasket - Lower valve plate
17	AM 5949	AM 5949	AM 5949	AM 5949	Guarnizione superiore piastra valvole Gasket - Upper valve plate
18	AM 5940	AM 5940	AM 5940	AM 5940	Guarnizione coperchio cuscin. posteriore Gasket
20	AM 5941	AM 5941	AM 5941	AM 5941	Guarnizione ovale per rubinetto Gasket
22	AM 5944	AM 5944	AM 5944	AM 5944	Guarnizione rotonda Gasket
31	AM 5931	AM 5931	AM 5931	AM 5931	Basamento Bottom plate
32	AM 5936	AM 5936	AM 5936	AM 5936	Flangia anteriore Front flange
40	AM 5928	AM 5928	AM 5928	AM 5928	Valvola sicurezza AP Pressure relief valve
45	AM 5938	AM 5938	AM 5938	AM 5938	Testata con guarnizione Cylinder head
ACCESSORI ED ATTREZZATURA - ACCESSORIES AND TOOLS					
265	AM 5925	AM 5925	AM 5925	AM 5925	Kit parzializzatore Capacity regulator kit
284	AM 5917	AM 5917	AM 5917	AM 5917	Particolari fissaggio bobina Coil fixation
RUBINETTI - SHUT-OFF VALVES					
4-5	AM 5927	AM 5927	AM 5927		Rubinetto aspirazione/mandata con flangia Ø 28 mm Ø 28 mm Suction/discharge shut-off valve complete
		AM 5926	AM 5926	AM 5926	Rubinetto aspirazione/mandata con flangia Ø 35 mm Ø 35 mm Suction/discharge shut-off valve complete
	AM 5929	AM 5929	AM 5929	AM 5929	Rubinetto senza flangia Shut-off valve without flange

RICAMBI COMPRESSORI BITZER (4 CILINDRI)

Bitzer Compressors spare parts (4 cylindres)





Pos. Pos.		AM 7435 4UFCY	AM 7460 4TFCY	AM 7461 4PFCY	AM 7462 4NFCY	Descrizione Description	OEM/Note OEM/Note
1			AM 5952				
				AM 5923		Kit guarnizioni completo Gasket kit	
					AM 5935		
		AM 5937					

RICAMBI COMPRESSORI BITZER (4 CILINDRI)

Bitzer Compressors spare parts (4 cylindres)

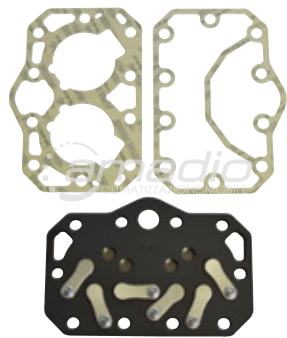
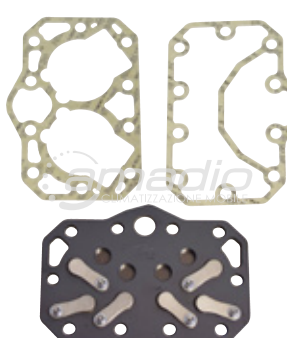
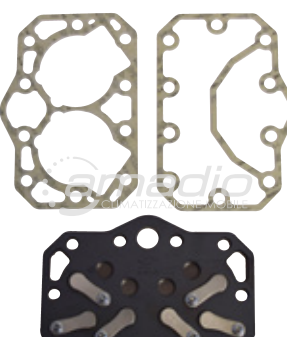

Pos. Pos.		AM 7435 4UFCY	AM 7460 4TFCY	AM 7461 4PFCY	AM 7462 4NFCY	Descrizione Description	OEM/Note OEM/Note
		AM 5966					
2			AM 5932			Kit piastra valvole Valve plate kit	
				AM 5933			
					AM 5956		
6		AM 5921	AM 5921	AM 5921	AM 5921	Kit premistoppa Shaft seal kit	

RICAMBI COMPRESSORI BITZER (4 CILINDRI)

Bitzer Compressors spare parts (4 cylindres)



Pos. Pos.		AM 7435 4UFCY	AM 7460 4TFCY	AM 7461 4PFCY	AM 7462 4NFCY	Descrizione Description	OEM/Note OEM/Note
7			AM 5947			Kit pistone Piston kit	
				AM 5934			
					AM 5945		
12		AM 5922	AM 5922	AM 5922	AM 5922	Cuscinetto anteriore Front bearing	
15		AM 5930	AM 5930	AM 5930	AM 5930	Guarnizione basamento Gasket	
16			AM 5954			Guarnizione inferiore piastra valvole Gasket - Lower valve plate	
				AM 5948			A0008352323
16					AM 5957	Guarnizione inferiore piastra valvole Gasket - Lower valve plate	

RICAMBI COMPRESSORI BITZER (4 CILINDRI)

Bitzer Compressors spare parts (4 cylindres)







Pos. Pos.		AM 7435 4UFCY	AM 7460 4TFCY	AM 7461 4PFCY	AM 7462 4NFCY	Descrizione Description	OEM/Note OEM/Note
17		AM 5949	AM 5949	AM 5949	AM 5949	Guarnizione superiore piastra valvole Gasket - Upper valve plate	
18		AM 5940	AM 5940	AM 5940	AM 5940	Guarnizione Coperchio cuscin. posteriore	
20		AM 5941	AM 5941	AM 5941	AM 5941	Guarnizione coperchio cuscin. posteriore Gasket	
22		AM 5944	AM 5944	AM 5944	AM 5944	Guarnizione rotonda Gasket	
31		AM 5931	AM 5931	AM 5931	AM 5931	Basamento Bottom plate	
32		AM 5936	AM 5936	AM 5936	AM 5936	Flangia anteriore Front flange	
40		AM 5928	AM 5928	AM 5928	AM 5928	Valvola sicurezza AP Pressure relief valve	
45		AM 5938	AM 5938	AM 5938	AM 5938	Testata con guarnizione Cylinder head	

RICAMBI COMPRESSORI BITZER (4 CILINDRI)

Bitzer Compressors spare parts (4 cylindres)

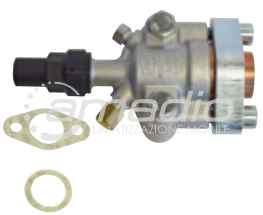

Pos. Pos.		AM 7435 4UFCY	AM 7460 4TFCY	AM 7461 4PFCY	AM 7462 4NFCY	Descrizione Description	OEM/Note OEM/Note
ACCESSORI E ATTREZZATURA - ACCESSORIES AND TOOLS							
265		AM 5925	AM 5925	AM 5925	AM 5925	Kit parzializzatore Capacity r egulator kit	
284		AM 5917	AM 5917	AM 5917	AM 5917	Particolari fissaggio bobina Coil fixation	
RUBINETTI - SHUT-OFF VALVES							
4/5		AM 5927	AM 5927	AM 5927		Rubinetto aspira- zione/mandata con flangia Ø 28 mm Ø 28 mm Suction/ discharge shut-off valve complete	
			AM 5926	AM 5926	AM 5926	Rubinetto aspira- zione/mandata con flangia Ø 35 mm Ø 35 mm Suction/ discharge shut-off valve complete	
		AM 5929	AM 5929	AM 5929	AM 5929	Rubinetto senza flangia Shut-off valve without flange	1102867A

COMPRESSORI BITZER (6 CILINDRI)

Bitzer Compressors (6 cylindres)



Dati Tecnici / Technical Data	
Cilindrata Displacement	Varianti: 600/713/836/970
Numero Cilindri No. of Cylinders	6
Refrigerante Refrigerant	R134a
Tipo Olio Oil Type	SE 55 AM 5105 (L 1) AM 5098 (L 5)
Quantità Olio Oil Quantity	2,5 L
Giri MAX Maximun Speed	500-3000 min

SERIE 6

COMPLETO

Codice Code	Descrizione Description	Cilindrata Displacement	Quantità Olio Oil quantity	Codice Olio Oil code	OEM/Note OEM/Note
AM 7551	Compressore Bitzer 6TFCY	713 cc	FUCHS SE 55 - LT. 2,5	AM 5105 (L 1) AM 5098 (L 5)	
AM 7711	Compressore Bitzer 6NFCY	970 cc	FUCHS SE 55 - LT. 2,5	AM 5105 (L 1) AM 5098 (L 5)	

RICAMBI COMPRESSORI BITZER (6 CILINDRI)
Bitzer Compressors spare parts (6 cylindres)

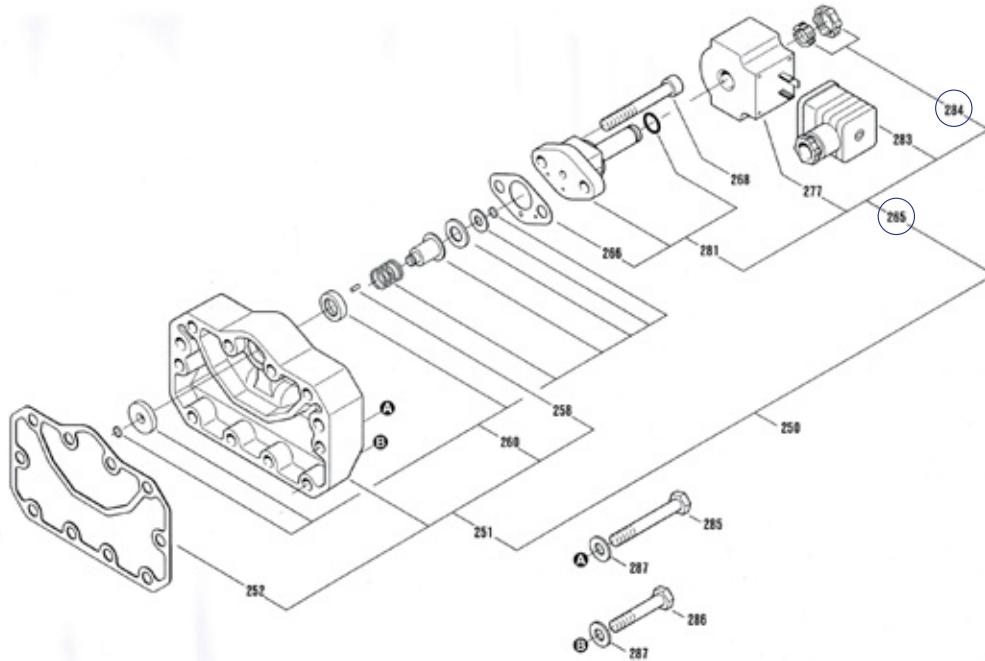

6UFC .. 6NFC

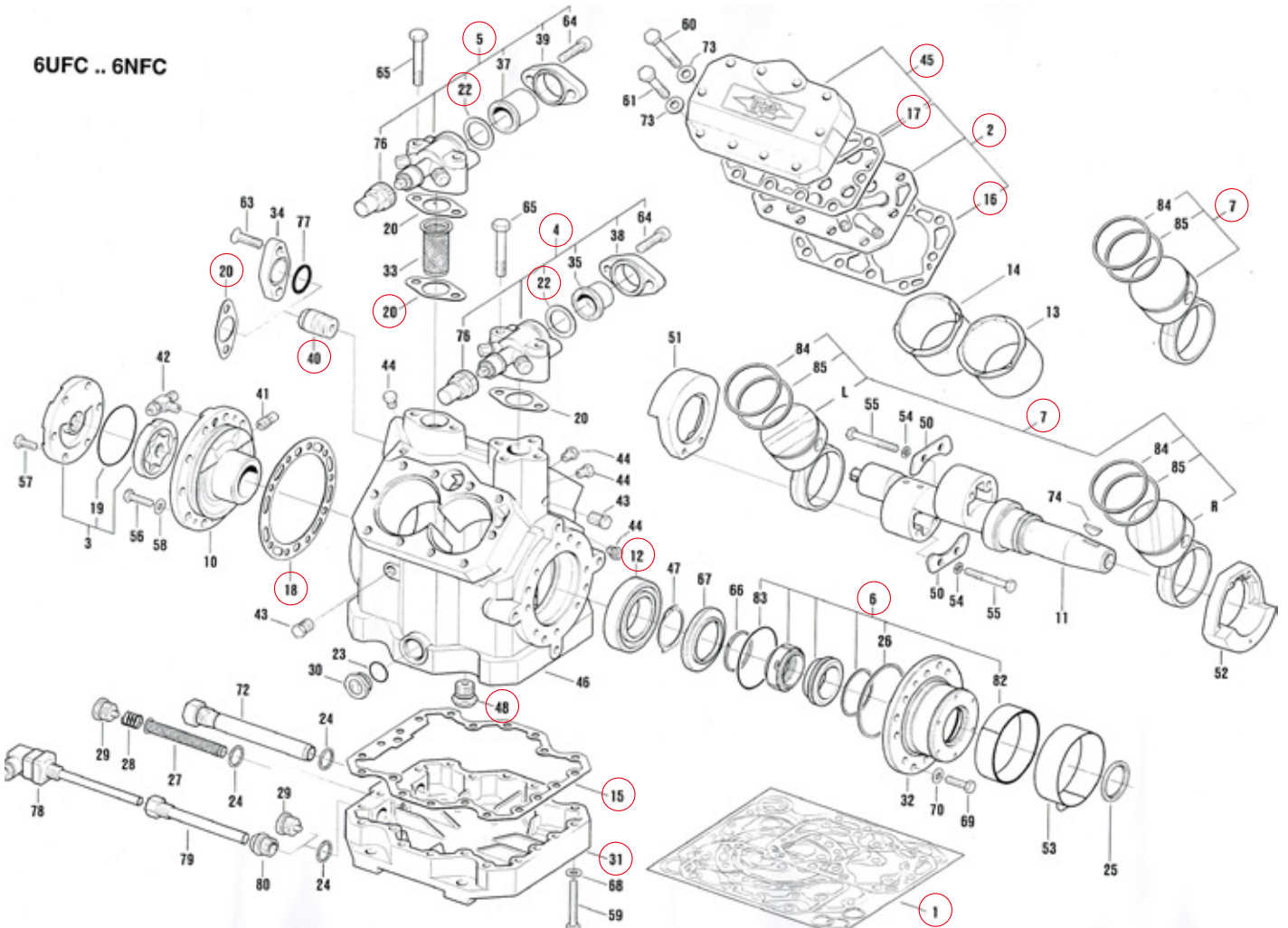

RICAMBI COMPRESSORI BITZER (6 CILINDRI)

Bitzer Compressors spare parts (6 cilindres)







Posizione Position	AM 7551 6TFCY	AM 7711 6NFCY	Descrizione Description
1	AM 5952	AM 5935	Kit guarnizioni completo Gasket kit
	AM 5941	AM 5941	Serie guarnizioni KV6 Gasket set
	AM 5944	AM 5944	Guarnizione collettore rubinetto Gasket
2	AM 5932	AM 5956	Kit piastra valvole KV6 KV6 Valve plate kit
3	AM 5955	AM 5955	Kit pompa olio KV4-KV5-KV6 Oil pump kit
6	AM 5921	AM 5921	Premistoppa KV4-5-6 Shaft seal
12	AM 5922	AM 5922	Cuscinetto anteriore per KV5 Front bearing
15	AM 5930	AM 5930	Guarnizione basamento compr. KV4-5-6 Gasket
16	AM 5934	AM 5957	Guarnizione inferiore piastra valvole Gasket - Lower valve plate
17	AM 5949	AM 5949	Guarnizione superiore piastra valvole Gasket - Upper valve plate
18	AM 5940	AM 5940	Guarnizione coperchio cuscin. posteriore Gasket
25	AM 5918	AM 5918	Guarnizione frontale paraolio Gasket
32	AM 5936	AM 5936	Flangia anteriore Front flange
45	AM 5938	AM 5938	Testata con guarnizione Cylinder head
66	AM 5919	AM 5919	Guarnizione anulare 51x47x2 51x47x2 Gasket
RUBINETTI - SHUT-OFF VALVES			
4-5	AM 5926	AM 5926	Rubinetto aspirazione/mandata con flangia Ø 35 mm Ø 35 mm Suction/discharge shut-off valve complete
4-5	AM 5929	AM 5929	Rubinetto senza flangia Shut-off valve without flange

RICAMBI COMPRESSORI BITZER (6 CILINDRI)

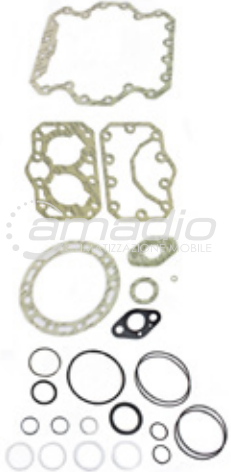
Bitzer Compressors spare parts (6 cylindres)











Pos. Pos.		AM 7551 6TFCY	AM 7711 6NFCY	Descrizione Description	OEM/Note OEM/Note
1		AM 5952		Kit guarnizioni completo Gasket kit	
			AM 5935		
		AM 5941	AM 5941	Serie guarnizioni KV6 Gasket set	
		AM 5944	AM 5944	Guarnizione collettore rubinetto Gasket	
2		AM 5932	AM 5956	Kit piastra valvole KV6 KV6 Valve plate kit	

RICAMBI COMPRESSORI BITZER (6 CILINDRI)

Bitzer Compressors spare parts (6 cilindres)



Pos. Pos.		AM 7551 6TFCY	AM 7711 6NFCY	Descrizione Description	OEM/Note OEM/Note
3		AM 5955	AM 5955	Kit pompa olio KV4-KV5-KV6 Oil pump kit	
6		AM 5921	AM 5921	Premistoppa KV4-5-6 Shaft seal	
12		AM 5922	AM 5922	Cuscinetto anteriore per KV5 Front bearing	
15		AM 5930	AM 5930	Guarnizione basamento compr. KV4-5-6 Gasket	
16		AM 5934	AM 5957	Guarnizione inferiore piastra valvole Gasket - Lower valve plate	
17		AM 5949	AM 5949	Guarnizione superiore piastra valvole Gasket - Upper valve plate	
18		AM 5940	AM 5940	Guarnizione coperchio cuscin. posteriore Gasket	
25		AM 5918	AM 5918	Guarnizione frontale paraolio Gasket	
32		AM 5936	AM 5936	Flangia anteriore Front flange	

RICAMBI COMPRESSORI BITZER (6 CILINDRI)

Bitzer Compressors spare parts (6 cylindres)



Pos. Pos.		AM 7551 6TFCY	AM 7711 6NFCY	Descrizione Description	OEM/Note OEM/Note
45		AM 5938	AM 5938	Testata compressore con guarnizione Cylinder head	
66		AM 5919	AM 5919	Guarnizione anulare 51x47x2 51x47x2 Gasket	
RUBINETTI - SHUT-OFF VALVES					
4-5		AM 5926	AM 5926	Rubinetto aspirazione/mandata con flangia Ø 35 mm Ø 35 mm Suction/discharge shut-off valve complete	
4-5		AM 5929	AM 5929	Rubinetto senza flangia Shut-off valve without flange	

Qualsiasi altro ricambio disponibile su richiesta - Every other model available upon request

PER ELETTROFRIZIONI E COMPONENTI vedi catalogo n. 02



COMPRESSORI HISPACOLD

HISPACOLD Compressors



Compressori Hispacold - 1A Serie



1^A SERIE - OLD VERSION

Dati Tecnici / Technical Data

Cilindrata Displacement	Varianti: 498/600
Numero Cilindri No. of Cylinders	4
Refrigerante Refrigerant	R134a/R404A/R407CF/R507/R22
Tipo Olio Oil Type	Castrol SW68 (o Equiv.)
Quantità Olio Oil Quantity	3500 cc
Giri MAX Maximun Speed	2800 r.p.m.
Inclinazione MAX Maximun Inclination	15°
Raccordo Aspirazione Suction Fitting	16 mm - 5/8 "
Raccordo Mandata Discharge Fitting	16 mm - 5/8 "

4 CILINDRI

6 CILINDRI

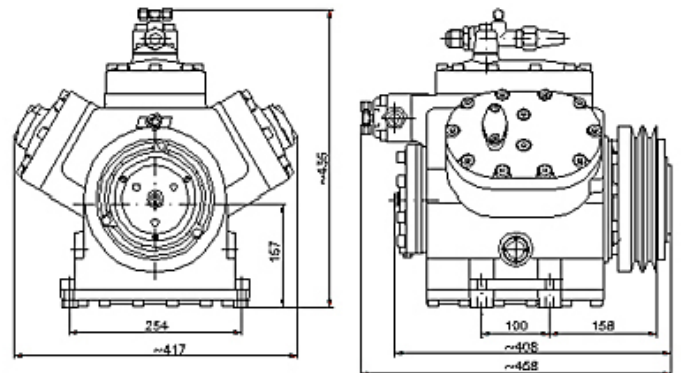
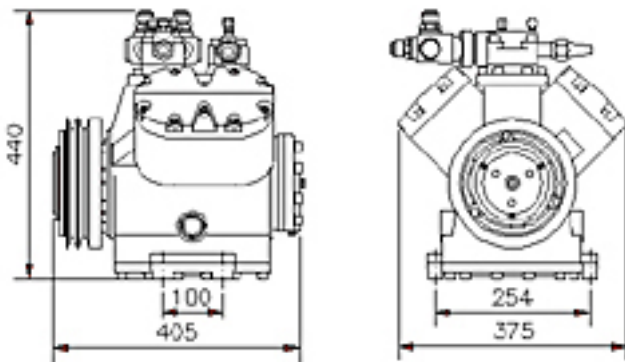

Posizione Position	Codice Code	Descrizione Description	Versione Version	OEM/Note OEM/Note
1		Compressore Hispacold 500 Hispacold 500 compressor	4 Cilindri 4 Cylinders	
2	AM 7447	Compressore Hispacold 600 Hispacold 600 compressor	4 Cilindri 4 Cylinders	
3	AM 7445	Compressore Hispacold 600 Hispacold 600 compressor	6 Cilindri 6 Cylinders	

RICAMBI COMPRESSORI HISPACOLD
HISPACOLD Compressors spare parts



1^A SERIE - OLD VERSION

4 CILINDRI

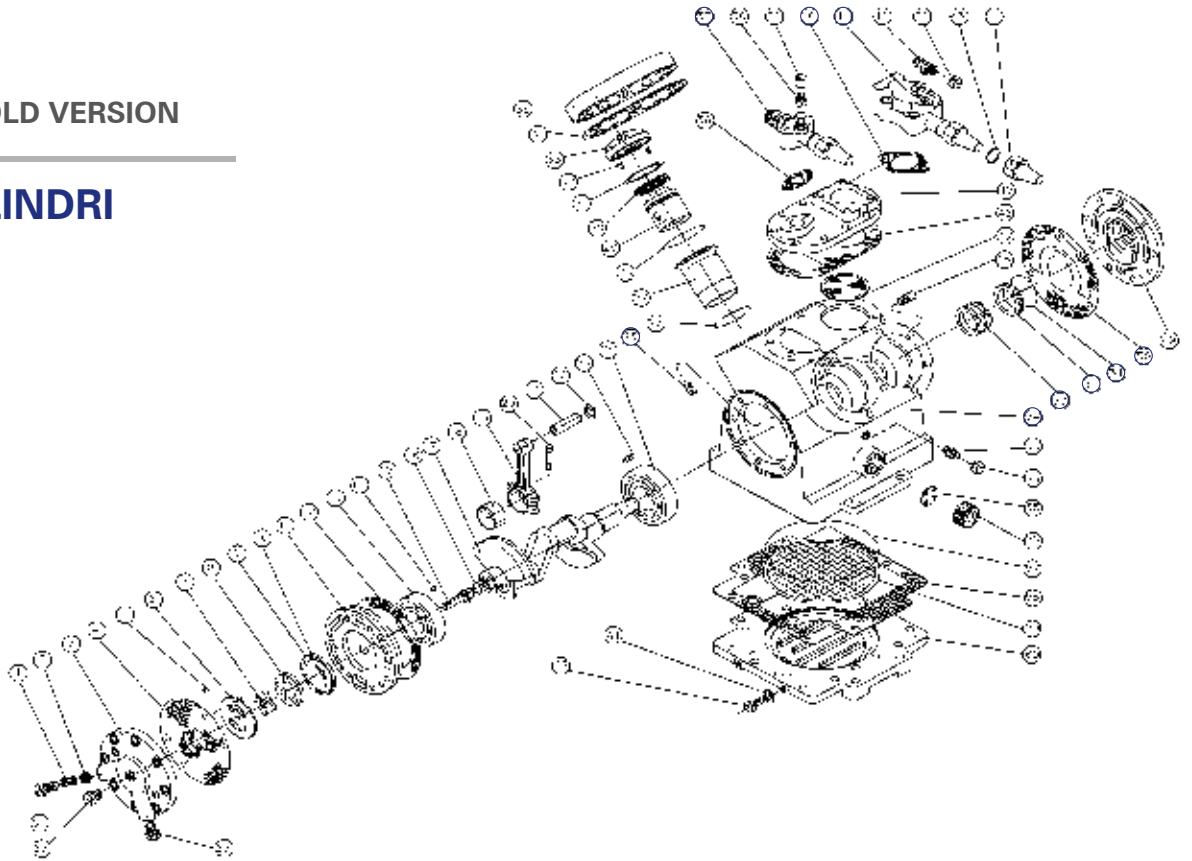

1^A SERIE - OLD VERSION

6 CILINDRI

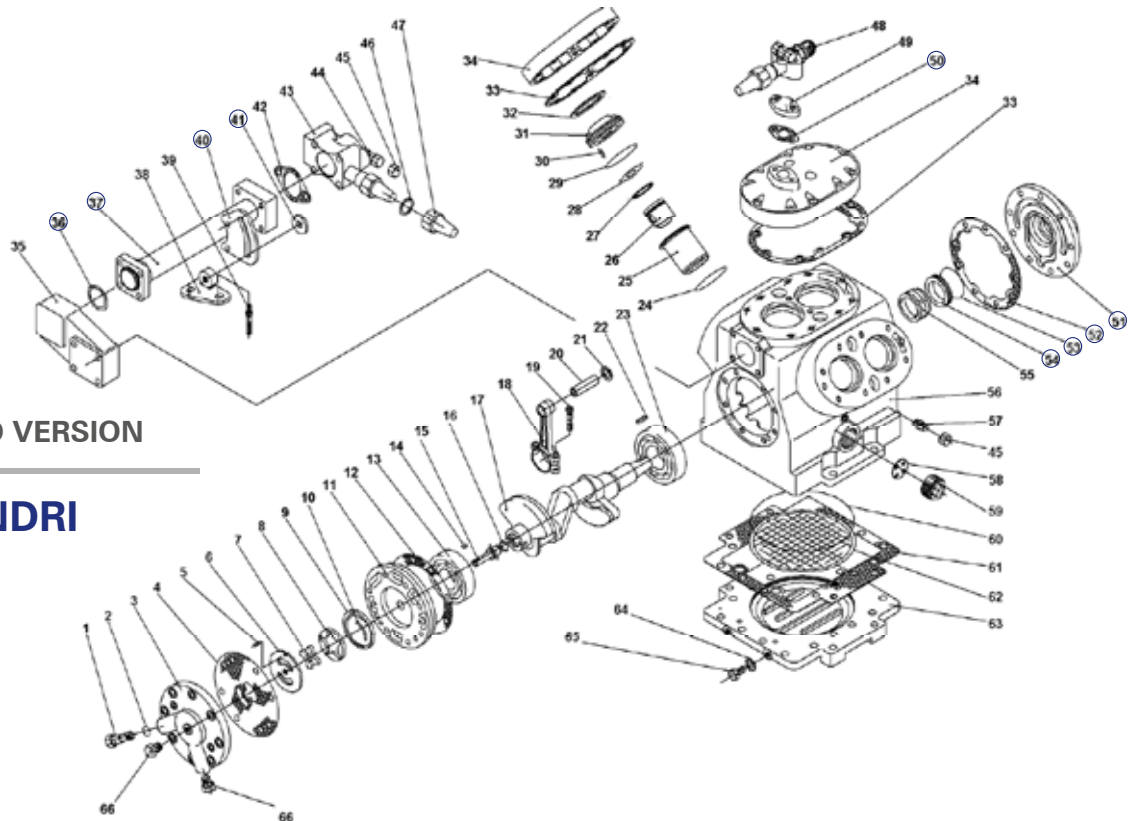

RICAMBI COMPRESSORI HISPACOLD

HISPACOLD Compressors spare parts



Compressori Hispacold - 1A Serie

Posizione Position 4 cilindri	Posizione Position 6 cilindri		Codice Code	Descrizione Description	OEM/Note OEM/Note
			AM 5168	Olio compressore SW68 SW68 compressor oil	4-6 cilindri
36	50		AM 5385	Guarnizione rubinetto AP Gasket	4-6 cilindri
40	42		AM 5352	Guarnizione rubinetto scarico Gasket	4-6 cilindri
37	48		AM 5380	Rubinetto AP O-ring HP Shut-off valve	4-6 cilindri
41	53		AM 5391	Rubinetto BP O-ring LP Shut-off valve valve	4-6 cilindri
50 > 53			AM 5467	Premistoppa Set-shaft seal	4-6 cilindri
			AM 5473	Kit guarnizioni Gasket kit	4 cilindri

RICAMBI COMPRESSORI HISPACOLD

HISPACOLD Compressors spare parts



Compressori Hispacold - 1A Serie

Posizione Position 4 cilindri	Posizione Position 6 cilindri		Codice Code	Descrizione Description	OEM/Note OEM/Note
			AM 5474	Kit guarnizioni Gasket kit	6 cilindri
	36		AM 5486	Guarnizione collettore BP 47x37 mm Gasket	
18			AM 5376	Bronzina	4 cilindri

Qualsiasi altro ricambio disponibile su richiesta - Every other model available upon request

PER ELETTROFRIZIONI E COMPONENTI vedi catalogo n. 02



COMPRESSORI HISPACOLD

HISPACOLD Compressors

ECOICE hispacold

Serie ECOICE - ECOICE Series



Dati Tecnici / Technical Data	
Cilindrata Displacement	Varianti: 550/660
Numero Cilindri No. of Cylinders	4
Refrigerante Refrigerant	R134a/R404A/R407CF/R507/R22
Tipo Olio Oil Type	Poe 68 (o Equiv.)
Quantità Olio Oil Quantity	2000 cc
Giri MAX Maximum Speed	3000 r.p.m.
Peso Weight	34 Kg

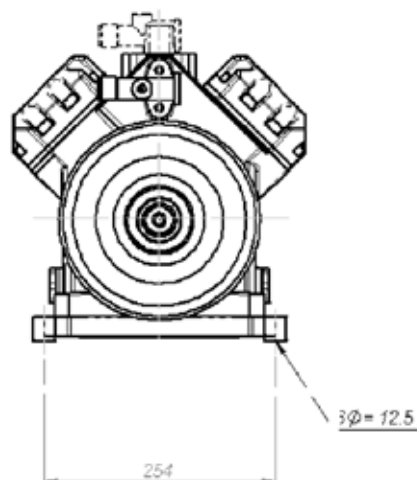

Posizione Position	Codice Code	Descrizione Description	Versione Version	OEM/Note OEM/Note
	AM	Compressore ECOICE 4V550 ECOICE 4V550 compressor		
	AM 7400	Compressore ECOICE 4V660 ECOICE 4V660 compressor		5741450 - 503128425 1070346

RICAMBI COMPRESSORI HISPACOLD

HISPACOLD Compressors spare parts



Ricambi compressori Hispacold - ECOICE 4V550/4V660

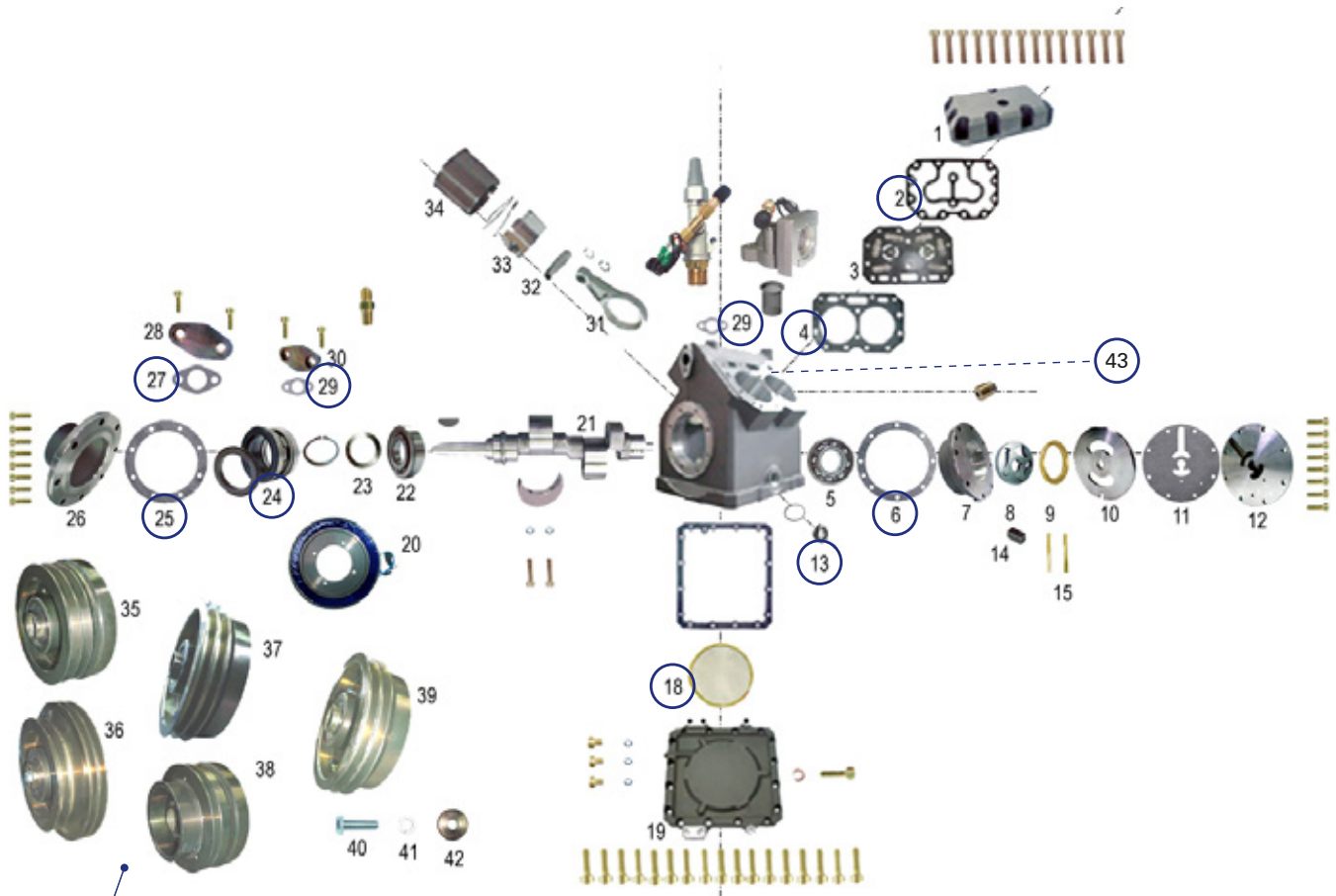

PER ELETTROFRIZIONI E COMPONENTI vedi catalogo n. 02

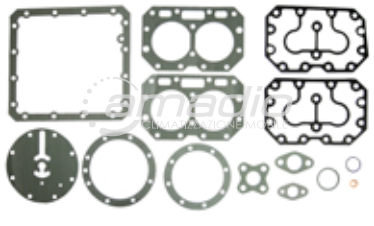
Posizione Position		Codice Code	Descrizione Description	OEM/Note OEM/Note
		AM 5168	Olio compressore SW68 SW68 compressor oil	
2/4/6/18 25/27/29		AM 5390	Kit guarnizioni Gaskets kit	

RICAMBI COMPRESSORI HISPACOLD

HISPACOLD Compressors spare parts

Ricambi compressori Hispacold - ECOICE 4V550/4V660

Posizione Position		Codice Code	Descrizione Description	OEM/Note OEM/Note
13		AM 5420	Vetro Spia Sight glass assy	
24		AM 5387	Kit premistoppa (flangia + premistoppa + guarnizioni) Crankshaft seal assy	
27		AM 5386	Guarnizione rubinetto BP Suction shut-off valve gasket	AH12122
29		AM 5385	Guarnizione rubinetto AP Discharge shut-off valve cover	3600101 - 12055 AH12055 - 825788
43		AM 5357	Guarnizione rubinetto Gasket	
		AM 5411	Rubinetto aspirazione dedicato Bova Shut-off valve	
		AM 5412	Rubinetto ritorno dedicato Bova Shut-off valve	

COMPRESSORI THERMO KING

THERMO KING Compressors



THERMO KING

Compressori Thermo king X430 - Thermo king X430 compressor



Dati Tecnici / Technical Data	
Cilindrata Displacement	492 cm ³
Numero Cilindri No. of Cylinders	4
Refrigerante Refrigerant	R134a/R407/R22
Tipo Olio Oil Type	Oil Poe 35 (o Equiv.) AM 5068
Quantità Olio Oil Quantity	4200 cc
Giri MAX Maximun Speed	2600 r.p.m.
Inclinazione MAX Maximun Inclination	10°
Peso Weight	35 Kg
Rotazione Rotation	Orario Clockwise

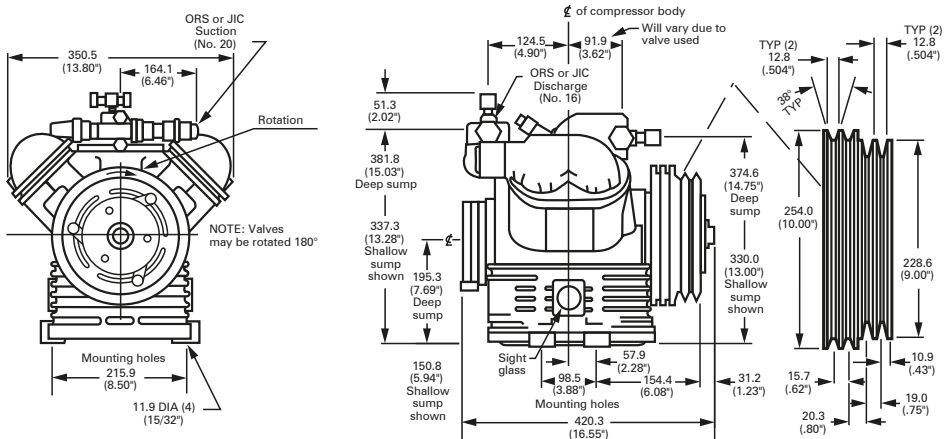

Codice Code	Descrizione Description	Note Note	OEM/Note OEM/Note
AM 7510F	Compressore Thermo King X430 Completo di frizione AM 7483 e pressostati	Su richiesta Available upon request	

RICAMBI COMPRESSORI THERMO KING
THERMO KING Compressors spare parts



THERMO KING

Compressori Thermo king X430 - Thermo king X430 compressor

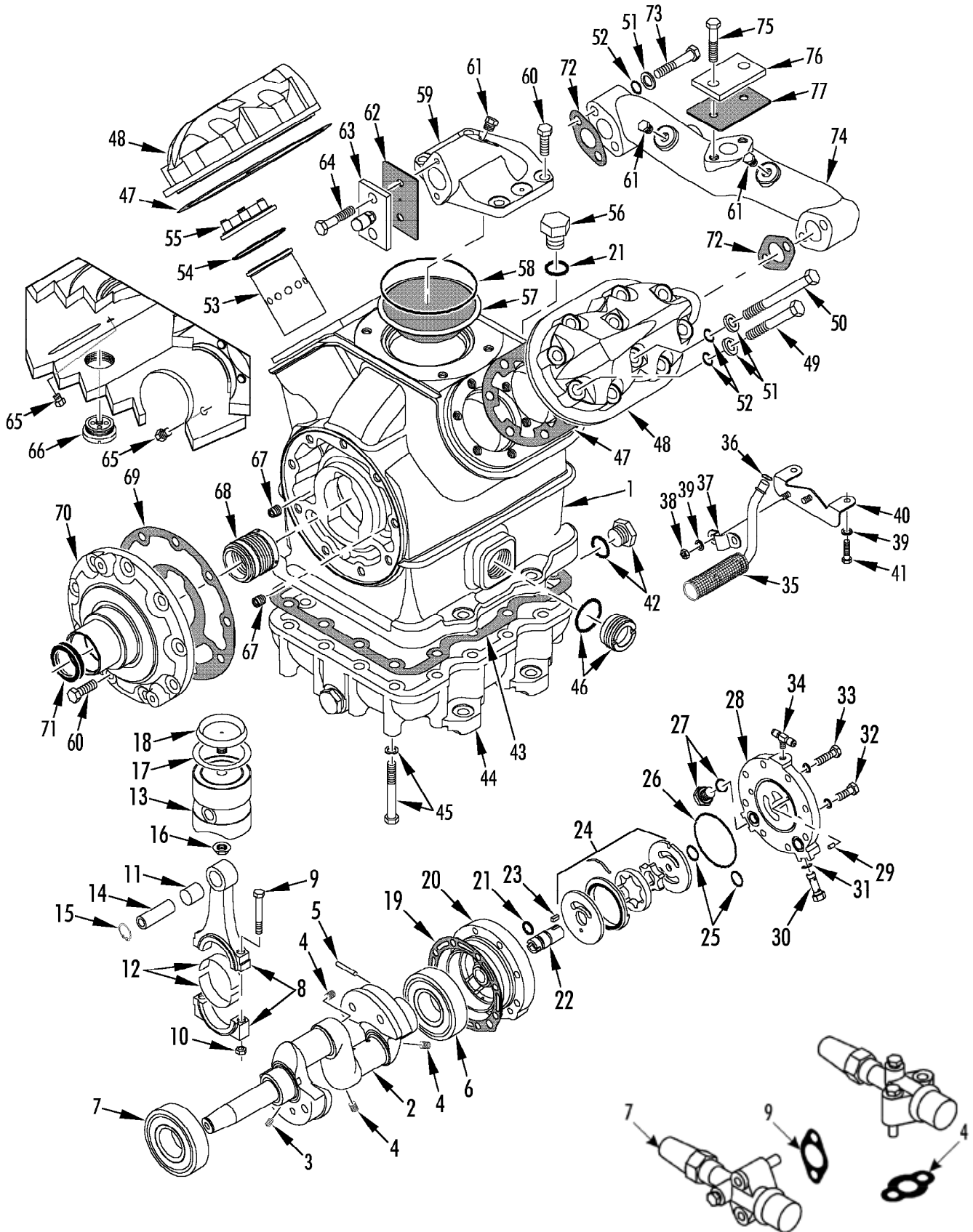

RICAMBI COMPRESSORI THERMO KING

THERMO KING Compressors spare parts



THERMO KING

Compressori Thermo king X430 - Thermo king X430 compressor

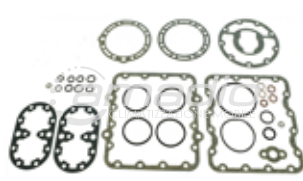
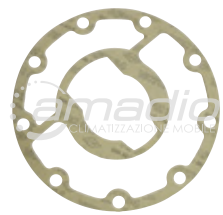
Posizione Position		Codice Code	Descrizione Description	OEM/Note OEM/Note
		AM 5068	Olio Viscosita 35 (Olio POE) Viscosity 35 Oil (POE Oil)	X426 X430
2		TKI 2251	Premistoppa vecchio tipo R12-R413 Shaft seal	X426 X430
2		TKI 2253	Premistoppa nuovo tipo R134-R404 Shaft seal	X426 X430
2		TKI 2255	Premistoppa Shaft seal	X426S
		TKI 2254	Kit guarnizioni Gasket kit	X426 X430
		TKI 2217	Guarnizione flangia premistoppa Gasket	X426 X430
2		TKI 2115	Rubinetto AP HP shut-off valve	X430

RICAMBI COMPRESSORI THERMO KING

THERMO KING Compressors spare parts



THERMO KING

Compressori Thermo king X430 - Thermo king X430 compressor

Posizione Position		Codice Code	Descrizione Description	OEM/Note OEM/Note
3		TKI 2117	Rubinetto BP L.P shut-off valve	X430
		TKI 2118	Rubinetto scarico Shut-off valve	X426 X430
		TKI 2119	Rubinetto aspirazione Shut-off valve	X426 X430
		TKI 2019	Paragrasso frizione - posteriore	
		TKI 2020	Paragrasso frizione - anteriore	

Qualsiasi altro modello disponibile su richiesta - Every other model available upon request

PER ELETTROFRIZIONI E COMPONENTI vedi catalogo n. 02

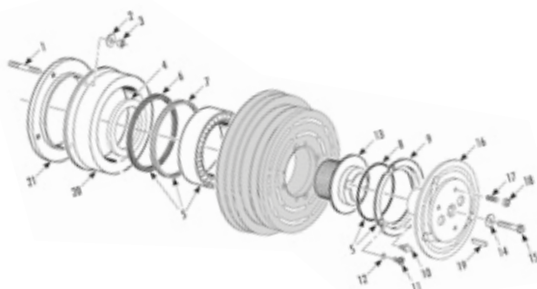

COMPRESSORI DORIN

DORIN Compressors

Ricambi Compressore Dorin V54 - Dorin V54 Compressor spare parts

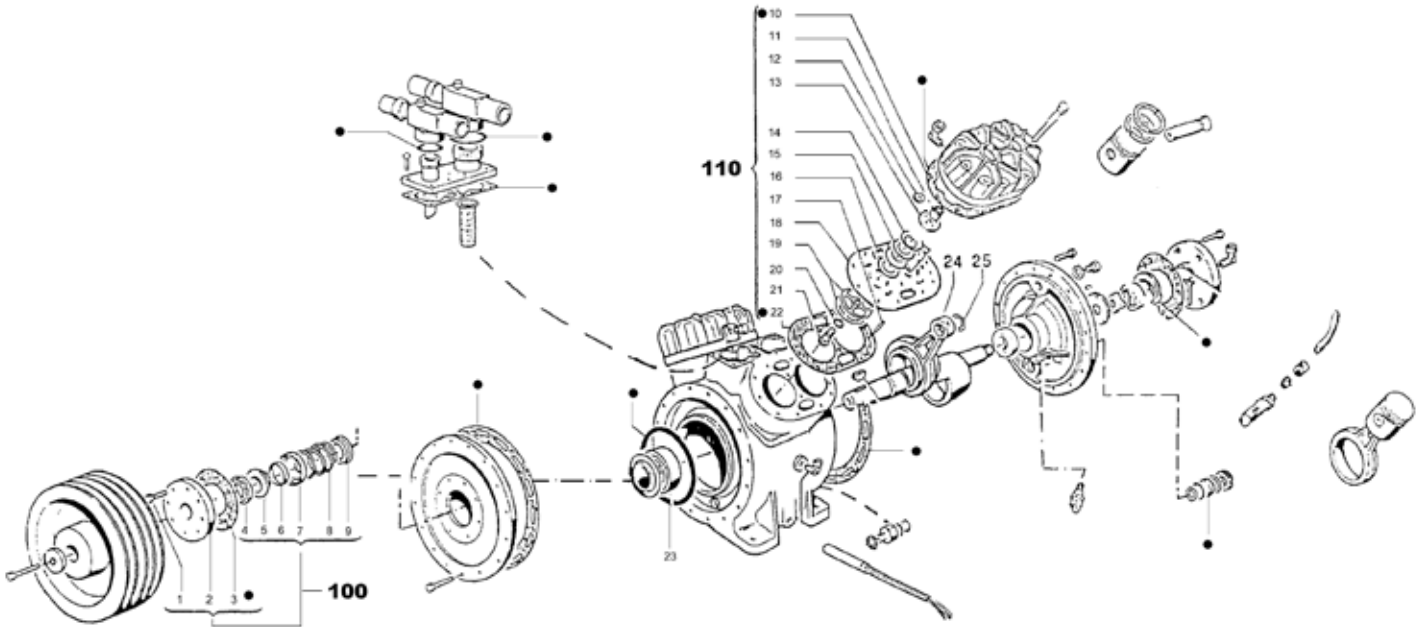

Posizione Position		Codice Code	Descrizione Description	Note Note	OEM/Note OEM/Note
23		AM 5457	Cuscinetto posteriore Rear bearing	Ad esaurimento	

COMPRESSORI DORIN

DORIN Compressors

Compressore Dorin 4T - Dorin 4T compressor



Dati Tecnici / Technical Data	
Cilindrata Displacement	Varianti: 118/143/170
Numero Cilindri No. of Cylinders	2
Refrigerante Refrigerant	R134a/R404A/R407CF/R507/R22
Tipo Olio Oil Type	Reniso Triton SE 55 (o Equiv.) N.B. per gas R22 Reniso SP 46 (o Equiv.)
Quantità Olio Oil Quantity	2000 cc
Giri MAX Maximun Speed	3000 r.p.m.
Inclinazione MAX Maximun Inclination	15°

FUORI PRODUZIONE / Availability: out of production

Si informa che il compressore DORIN serie 4T è uscito di produzione.
È STATO SOSTITUITO DALLA SERIE 4D che trovate specificato nella pagine seguenti.

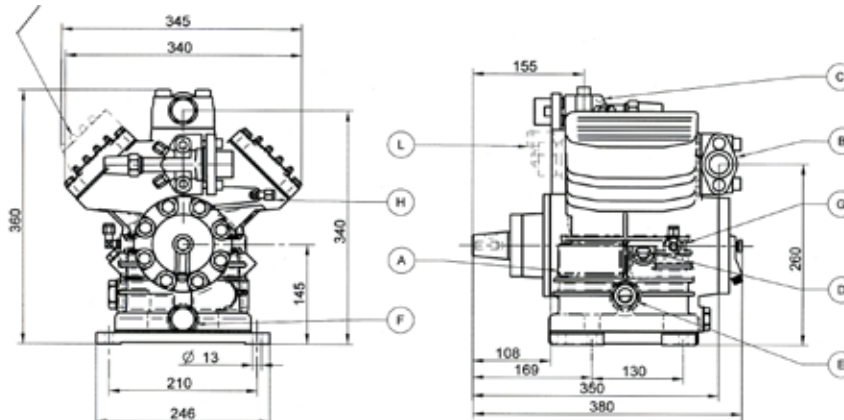

Codice Code	Descrizione Description	Cilindrata Displacement	Quantità olio Oil quantity	OEM/Note OEM/Note
	Compressore 4T-39 4T-39 compressor	360 cc		
	Compressore 4T-44 4T-44 compressor	445cc		
AM 7448	Compressore 4T-57 4T-57 compressor	530 cc		
AM 7449	Compressore 4T-65 4T-65 compressor	650 cc		

COMPRESSORI DORIN

DORIN Compressors

Ricambi compressore Dorin 4T - Dorin 4T compressor

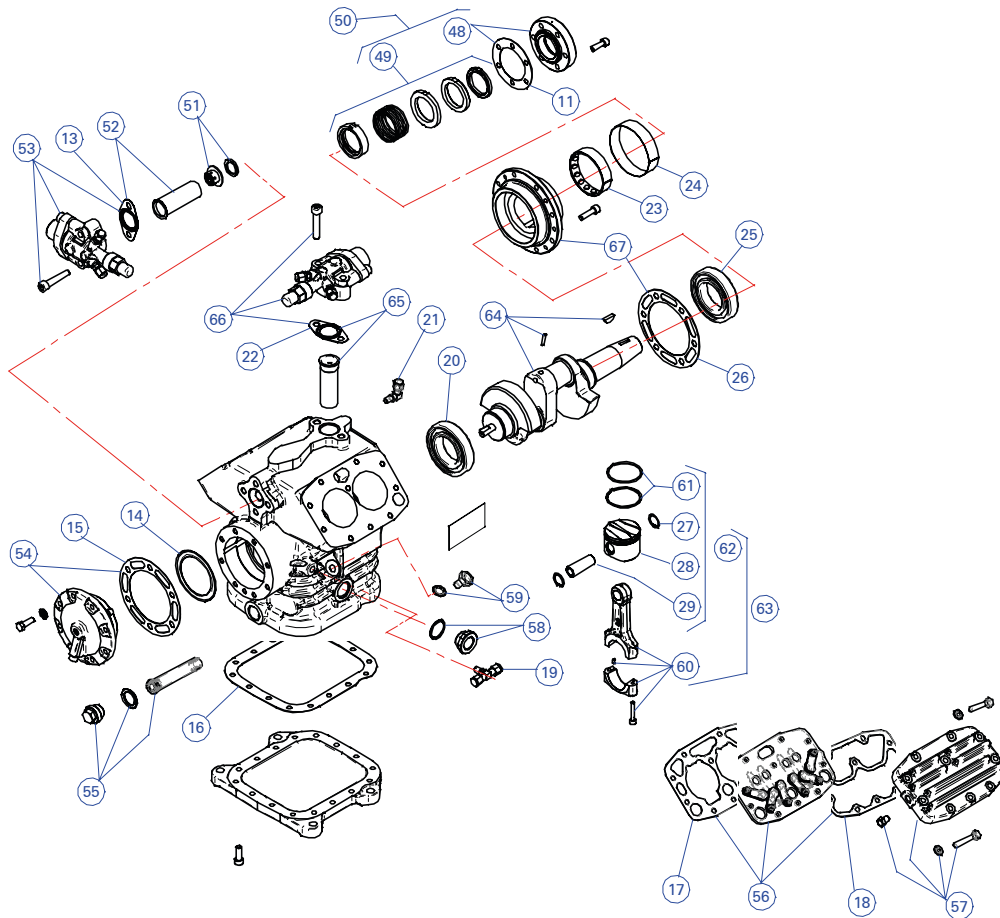









Posizione Position		Codice Code	Descrizione Description	Note Note	OEM/Note OEM/Note
11		AM 7507	Guarnizione flangia Gasket		
16		AM 7467	Guarnizione basamento Gasket		
22-13		AM 7469	Guarnizione filtro flangia rubinetto Gasket		
23		AM 7538	Feltrino assorbi olio Oil belt		
26		AM 5417	Guarnizione mozzo anteriore Gasket		

COMPRESSORI DORIN

DORIN Compressors

Ricambi compressore Dorin 4T - Dorin 4T compressor

Posizione Position		Codice Code	Descrizione Description	Note Note	OEM/Note OEM/Note
50		AM 7463	Premistoppa Shaft seal		
53		AM 7491	Rubinetto aspirazione Shut-off valve		
56		AM 7465	Kit piastra valvole Valve plate kit		
57		AM 7490	Testata con bulloni Cylinder head		
63		AM 7430	Kit pistone + biella Piston kit + connecting rod kit	4T57	
65		AM 7468	Pescante rubinetto Height of suction		
66		AM 7492	Rubinetto mandata Shut-off valve		
		AM 7466	Kit guarnizioni Gasket kit		
NO POS.		AM 7429	Kit parzializzatore Capacity regulator kit		

COMPRESSORI DORIN

DORIN Compressors

Compressore Dorin 4D - Dorin 4D compressor



Dati Tecnici / Technical Data	
Cilindrata Displacement	492/561/654/733
Numero Cilindri No. of Cylinders	4
Refrigerante Refrigerant	R134a
Tipo Olio Oil Type	SE 55 AM 5105 (L 1) AM 5098 (L 5)
Quantità Olio Oil Quantity	2,1
Giri MAX Maximun Speed	500 - 3500 min

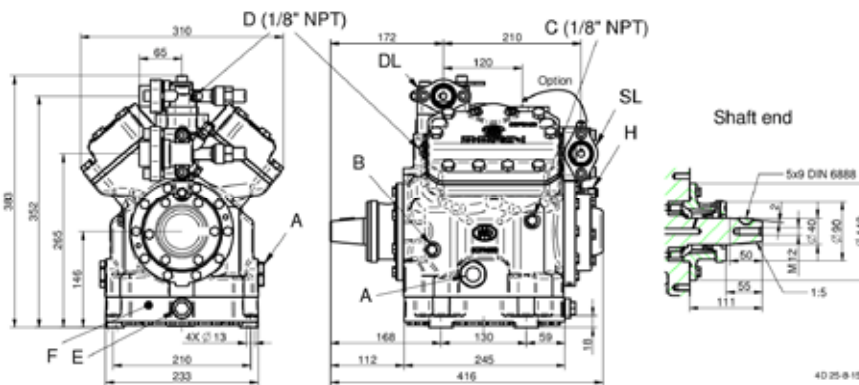

Codice Code	Descrizione Description	Cilindrata Displacement	Quantità olio Oil quantity	OEM/Note OEM/Note
AM 7571	Compressore 4D-49 4D-49 compressor	492 cc		
AM 7570	Compressore 4D-56 4D-56 compressor	561 cc		Sostituisce 7448
AM 7569	Compressore 4D-65 4D-65 compressor	654 cc		
AM 7572	Compressore 4D-73 4D-73 compressor	733 cc		

Qualsiasi ricambio disponibile su richiesta - Every spare part available upon request

COMPRESSORI CARRIER

CARRIER Compressors



Compressore Carrier 05G - Carrier 05G compressor

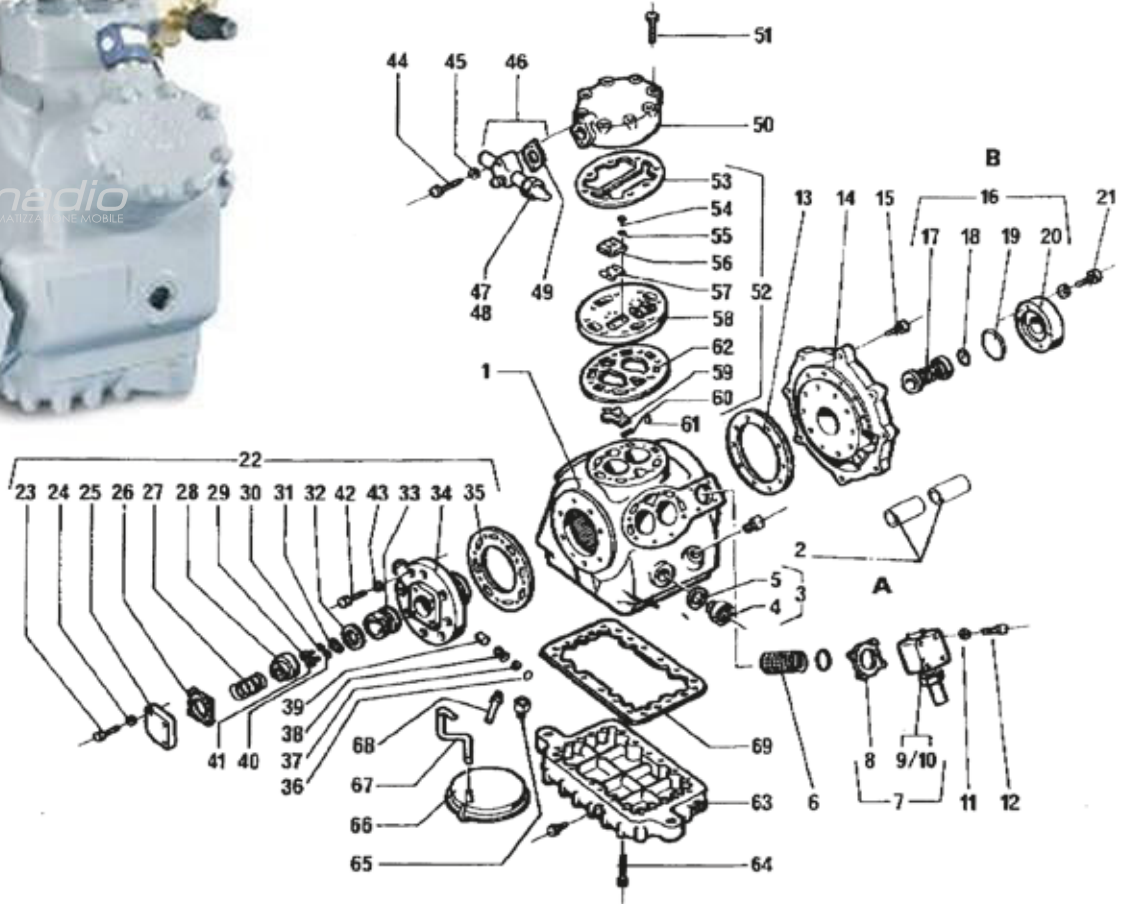

Posizione Position	Codice Code	Descrizione Description	Note Note	OEM/Note OEM/Note
	AM 5634	Premistoppa con flangia piatta Shaft seal with flat flange	05G	
	AM 5635	Premistoppa senza flangia Shaft seal without flange	05G	8862140003100 174477000 50799 24155
	TRA 140104207	Rubinetto mandata Shut-off valve	05G	
	TRA 174000201	Rubinetto aspirazione Shut-off valve	05G	

COMPRESSORI CARRIER

CARRIER Compressors



Compressore Carrier 5F30 - Carrier 5F30 compressor

FUORI PRODUZIONE
Availability: out of production

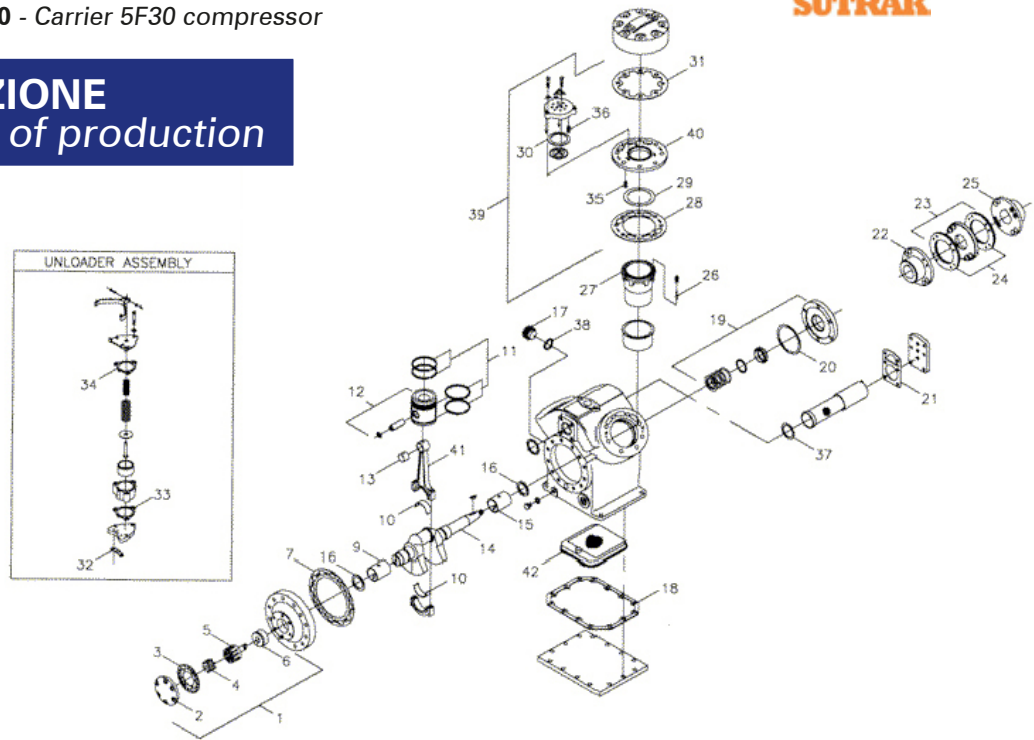

Posizione Position		Codice Code	Descrizione Description	Note Note	OEM/Note OEM/Note
		TRA 1710201	Serie guarnizioni completa Gasket kit	5F30	
		AM 5628	Premistoppa Shaft seal	5HG 5F20 5F30 5F40 5F60	8862140002700 1710302 171030200



F.Ili Amadio S.p.A.
Via Piave 37/A - 31028 - Vazzola fraz. Tezze (TV)
Tel. +39 0438 488181
info@amadiospa.it - www.amadiospa.it